

TOSHIBA

Leading Innovation >>>

Integrated High Definition LED Television Resource Guide

50M2U

NOTE Keep this Resource Guide in a convenient place to access important information about your television. To obtain additional information, consult the comprehensive electronic User's Guide at support.toshiba.com.

If you need assistance:

- ❖ Toshiba's Support Web site support.toshiba.com
- ❖ Toshiba Customer Support Center
Calling within the United States (800) 631-3811
Calling from outside the United States (949) 583-3050

Owner's Record

The model number and serial number are on the back and side of your television. Record these numbers whenever you communicate with your Toshiba dealer about this television.

Model name _____

Serial number _____

Register your Toshiba Television at register.toshiba.com.

Note: To display a High Definition picture, the TV must be receiving a High Definition signal (such as an over-the-air High Definition TV broadcast, a High Definition digital cable program, or a High Definition digital satellite program). For details, contact your TV antenna installer, cable provider, or satellite provider.

- When selecting a location for the TV, NEVER allow any part of the TV to hang over the edge of the supporting furniture.
- NEVER place the TV on tall furniture (for example, entertainment centers or bookcases) without anchoring both the furniture and the TV to a suitable support.
- Never place cloth or other material between the TV and the supporting furniture.
- NEVER allow children to climb on the TV.
- To avoid damage to this product, never place or store the TV in direct sunlight, hot, humid areas; or areas subject to excessive dust or vibration.
- Always place the TV on the floor or a sturdy, level, stable surface that can support the weight of the unit. To secure the TV, use a sturdy strap from the hook(s) on the rear of the TV to a wall stud, pillar, or other immovable structure. Make sure the strap is tight, secure, and parallel to the floor.

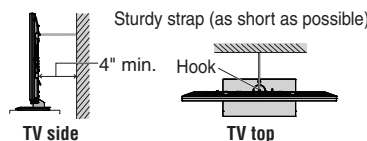

- openings are provided to protect the TV from overheating and to help maintain reliable operation of the TV.
- Never allow anything to rest on or roll over the power cord, and never place the TV where the power cord is subject to wear or abuse.
- Never overload wall outlets and extension cords.
- Always operate this equipment from a 120V AC, 60Hz power source.
- Always make sure the antenna system is properly grounded to provide adequate protection against voltage surges and built-up static charges (see Section 810 of the National Electric Code).

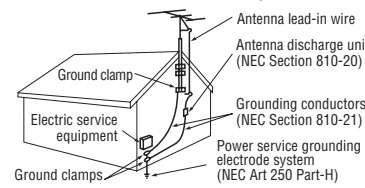

34) DANGER: RISK OF SERIOUS PERSONAL INJURY OR DEATH!

- Use extreme care to make sure you are never in a position where your body (or any item you are in contact with, such as a ladder or screwdriver) can accidentally touch overhead power lines.
- Never locate the antenna near overhead power lines or other electrical circuits.
- Never attempt to install any of the following during lightning activity: a) an antenna system; or b) cables, wires, or any home theater component connected to an antenna or phone system.

Care

For better performance and safer operation of your TOSHIBA TV, follow these

Dear Customer,
Thank you for purchasing this Toshiba LED TV. This guide will help you use the many exciting features of your new LED TV. Before operating your LED TV, carefully read this guide completely.

Safety Precautions
WARNING: TO REDUCE THE RISK OF FIRE OR ELECTRIC SHOCK, DO NOT EXPOSE THIS APPLIANCE TO RAIN OR MOISTURE.

WARNING: TO REDUCE THE RISK OF ELECTRIC SHOCK, DO NOT REMOVE COVER (OR BACK). NO USER-SERVICEABLE PARTS INSIDE. REFER SERVICING TO QUALIFIED SERVICE PERSONNEL.

The lightning flash with arrowhead symbol, within an equilateral triangle, is intended to alert the user to the presence of uninsulated "dangerous voltage" within the product's enclosure that may be of sufficient magnitude to constitute a risk of electric shock to persons.

The exclamation point within an equilateral triangle is intended to alert the user to the presence of important operating and maintenance (servicing) instructions in the literature accompanying the appliance.

WARNING To prevent injury, this apparatus must be securely attached to the floor/wall in accordance with the installation instructions. See instructions on item 26).

WARNING If you decide to wall mount this television, always use a mounting bracket that has been Listed by an independent laboratory (such as UL, CSA, ETL) and is appropriate for the size and weight of this television. The use of inappropriate or non-Listed mounting brackets could result in serious bodily injury and/or property damage. See "To Display your LED TV using a Wall Bracket." below.

CHILD SAFETY:

It Makes A Difference How and Where You Use Your Flat Panel Display

Congratulations on your purchase! As you enjoy your new product, please keep these safety tips in mind:

The Issue

- The home theater entertainment experience is a growing trend and larger flat panel displays are popular purchases. However, flat panel displays are not always supported on the proper stands or installed according to the manufacturer's recommendations.
- Flat panel displays that are inappropriately situated on dressers, bookcases, shelves, desks, speakers, chests, or carts may fall over and cause injury.

TOSHIBA Cares!

- The consumer electronics industry is committed to making home entertainment enjoyable and safe.

Tune Into Safety

- One size does NOT fit all. Follow the manufacturer's recommendations for the safe installation and use of your flat panel display.
- Carefully read and understand all enclosed instructions for proper use of this product.
- Don't allow children to climb on or play with furniture and television sets.

NOTE TO CATV INSTALLERS

This is a reminder to call the CATV system installer's attention to Article 820-40 of the U.S. NEC, which provides guidelines for proper grounding and, in particular, specifies that the cable ground shall be connected to the grounding system of the building, as close

- Don't place flat panel displays on furniture that can easily be used as steps, such as a chest of drawers.
- Remember that children can become excited while watching a program, especially on a "larger than life" flat panel display. Care should be taken to place or install the display where it cannot be pushed, pulled over, or knocked down.
- Care should be taken to route all cords and cables connected to the flat panel display so that they cannot be pulled or grabbed by curious children.

Wall Mounting: If you decide to wall mount your flat panel display, always:

- Use a mount that has been recommended by the display manufacturer and/or listed by an independent laboratory (such as UL, CSA, ETL).
- Follow all instructions supplied by the display and wall mount manufacturers.
- If you have any doubts about your ability to safely install your flat panel display, contact your retailer about professional installation.
- Make sure that the wall where you are mounting the display is appropriate. Some wall mounts are not designed to be mounted to walls with steel studs or old cinder block construction. If you are unsure, contact a professional installer.
- A minimum of two people are required for installation. Flat panel displays can be heavy.



to the point of cable entry as practical. For additional antenna grounding information, see 33) and 34).

Important Safety Instructions

- Read these instructions.
- Keep these instructions.
- Heed all warnings.
- Follow all instructions.
- Do not use this apparatus near water.
- Clean only with dry cloth.
- Do not block any ventilation openings. Install in accordance with the manufacturer's instructions.
- Do not install near any heat sources such as radiators, heat registers, stoves, or other products (including amplifiers) that produce heat.
- Do not defeat the safety purpose of the polarized or grounding type plug. A polarized plug has two blades with one wider than the other. A grounding type plug has two blades and a third grounding prong. The wide blade or the third prong are provided for your safety. If the provided plug does not fit into your outlet, consult an electrician for replacement of the obsolete outlet.
- Protect the power cord from being walked on or pinched, particularly at plugs, convenience receptacles, and the point where they exit from the apparatus.
- Only use attachments/accessories specified by the manufacturer.
- Use only with the cart, stand, tripod, bracket, or table specified by the manufacturer, or sold with the apparatus. When a cart is used, use caution when moving the cart/product combination to avoid injury from tip-over.
- Unplug this apparatus during lightning storms or when unused for long periods of time.



- Unplug and remove any cables and/or other component connectors from the rear of the TV.
- Remove the screws of the VESA Mounting Pattern shown in the table below.
CAUTION: Do not use the screws removed from the back cover to attach the wall mount bracket to the TV.
- Always use the screws supplied or recommended by the wall mount manufacturer.
- Follow the instructions provided with your wall bracket. Before proceeding, make sure the appropriate bracket(s) are attached to the wall and the back of the TV as described in the instructions provided with the wall bracket.
- After attaching the appropriate bracket(s) to the wall and the back of the TV, remove the pedestal stand from the TV, as described on this instruction document.
- VESA Mounting Pattern

| TV Size | Hole Pattern (HxV) | Screw Size |
|---------|--------------------|------------|
| 50M2U | 400x400 mm | M8 |

(unit in mm)

Removing the Pedestal Stand

- Carefully lay the front of the unit face down on a flat, cushioned surface such as a quilt or blanket. Leave the stand protruding over the edge of the surface.
- Extreme care should always be used when removing the pedestal stand to avoid damage to the LCD panel.
- Remove the screws shown in the below diagram. This will allow removal of the pedestal stand.
- Once you have removed all screws holding the pedestal stand in place, remove the pedestal stand from the TV.

- Refer all servicing to qualified service personnel. Servicing is required when the apparatus has been damaged in any way, such as power-supply cord or plug is damaged, liquid has been spilled or objects have fallen into the apparatus, the apparatus has been exposed to rain or moisture, does not operate normally, or has been dropped.

Additional Safety Precautions

- CAUTION: If the TV is dropped and the cabinet or enclosure surface has been damaged or the TV does not operate normally, take the following precautions:
 - ALWAYS turn off the TV and unplug the power cord to avoid possible electric shock or fire.
 - NEVER allow your body to come in contact with any broken glass or liquid from the damaged television. The LCD panel inside the TV contains glass and a toxic liquid. If the liquid comes in contact with your mouth or eyes, or your skin is cut by broken glass, rinse the affected area thoroughly with water and contact your doctor immediately.
 - ALWAYS contact a service technician to inspect the TV any time it has been damaged or dropped.
- CAUTION: To reduce the risk of electric shock, do not use the polarized plug with an extension cord, receptacle, or other outlet unless the blades can be inserted completely to prevent blade exposure.
- To prevent electric shock, match wide blade of plug to wide slot; fully insert.
- CAUTION: Do not let children swallow any small parts included on or with the product or play with the plastic bag. Keep the small parts and the plastic bag out of the reach of children.

- CAUTION: Do not let water or other liquids come into contact with the product, as it may result in damage.
- WARNING: To prevent the spread of fire, keep candles or other open flames away from this product at all times.
- Keep the product away from direct sunlight, fire or a heat source such as a heater. This may reduce the product lifetime or result in fire.
- Installation, Care, and Service Installation
Follow these recommendations and precautions and heed all warnings when installing your TV:
 - WARNING: NEVER expose the batteries to excessive heat such as sunshine, fire, or the like.
- ALWAYS plug the product into an outlet that is located in such a manner that it can be easily unplugged in case the product requires service.
- NEVER route the product's power cord inside a wall or similar enclosed area.
- Never modify this equipment. Changes or modifications may void: a) the warranty, and b) the user's authority to operate this equipment under the rules of the Federal Communications Commission.
- DANGER: RISK OF SERIOUS PERSONAL INJURY, DEATH, OR EQUIPMENT DAMAGE!
Never place the TV on an unstable cart, stand, or table. The TV may fall, causing serious personal injury, death, or serious damage to the TV.

50" TV

VESA Mounting Pattern

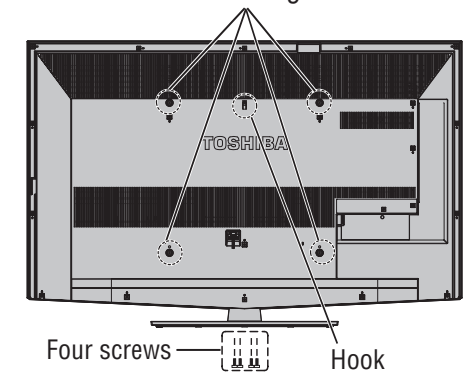

(Sample illustration)

Hook Sturdy strap (as short as possible)



GMA501096011 • 05/12

FCC Declaration of Conformity Compliance Statement (Part 15):

Toshiba 50M2U Television model complies with Part 15 of the FCC rules. Operation is subject to the following two conditions:

- (1) This device may not cause harmful interference, and
 - (2) This device must accept any interference received, including interference that may cause undesired operation.
- The party responsible for compliance to these rules is:
- Toshiba America Information Systems, Inc.
9740 Irvine Blvd., Irvine, CA 92618.
Phone: 800-631-3811

Note: This equipment has been tested and found to comply with the limits for a Class B digital device, pursuant to Part 15 of the FCC Rules. These limits are designed to provide reasonable protection against harmful interference in a residential installation. This equipment generates, uses, and can radiate radio frequency energy and, if not installed and used in accordance with the instructions, may cause harmful interference to radio communications. However, there is no guarantee that interference will not occur in a particular installation. If this equipment does cause harmful interference to radio or television reception, which can be determined by removing and applying power to the equipment, the user is encouraged to try to correct the interference by one of the following measures:

- Reorient or relocate the receiving antenna.
- Increase the separation between the equipment and receiver.
- Connect the equipment into an outlet on a circuit different from that to which the receiver is connected.

• Consult the dealer or an experienced radio/TV technician for help.

Caution: Changes or modifications to this equipment not expressly approved by Toshiba could void the user's authority to operate this equipment.

ENERGY STAR® User Information

ENERGY STAR User Information Statement: The factory default settings of this television meet ENERGY STAR® requirements. Changing Picture Settings may increase energy consumption, possibly beyond the limits required for ENERGY STAR qualification. To ensure your television is operating at optimal energy efficiency, select [Home] mode during initial activation. To return to [Home] mode settings, select [Standard] picture mode. [Standard] mode is recommended for normal home use.



ENERGY STAR® qualified TV. Products that earn the ENERGY STAR prevent green house gas emissions by meeting strict guidelines set by the U.S. Environmental Protection Agency. ENERGY STAR and the ENERGY STAR mark are registered U.S. marks.

Important notes about your TV

The following symptoms are technical limitations of LCD Display technology and are not an indication of malfunction; therefore, Toshiba is not responsible for perceived issues resulting from these symptoms.

- 1) An afterimage (ghost) may appear on the screen if a fixed, non-moving image appears for a long period of time. The afterimage is not permanent and will disappear in a short period of time.
- 2) The LCD panel contained in this TV is manufactured using an extremely high level of precision technology; however,

there may be an occasional pixel (dot of light) that does not operate properly (does not light, remains constantly lit, etc.). This is a structural property of LCD technology, is not a sign of malfunction, and is not covered under your warranty. Such pixels are not visible when the picture is viewed from a normal viewing distance.

Note: Interactive video games that involve shooting a "gun" type of joystick at an on-screen target may not work with this TV.

Trademark Information

- ColorStream is a registered trademark of Toshiba America Information Systems, Inc. and/or Toshiba Corporation.
- Manufactured under license from Dolby Laboratories. Dolby and the double-D symbol are trademarks of Dolby Laboratories.
- Blu-ray Disc™, Blu-ray™, and the logos are trademarks of the Blu-ray Disc Association.
- HDMI, the HDMI Logo, and High-Definition Multimedia Interface are trademarks or registered trademarks of HDMI Licensing LLC in the United States and other countries.
- All other brand and product names are trademarks or registered trademarks of their respective companies.

Copyright

This guide is copyrighted by Toshiba America Information Systems, Inc. with all rights reserved. Under the copyright laws, this guide cannot be reproduced in any form without the prior written permission of Toshiba. No patent liability is assumed, however, with respect to the use of the information contained herein. ©2012 by Toshiba America Information Systems, Inc. All rights reserved.

Notice

The information contained in this manual, including but not limited to any product specifications, is subject to change without notice. **TOSHIBA CORPORATION AND TOSHIBA AMERICA INFORMATION SYSTEMS, INC. (TOSHIBA) PROVIDES NO WARRANTY WITH REGARD TO THIS MANUAL OR ANY OTHER INFORMATION CONTAINED HEREIN AND HEREBY EXPRESSLY DISCLAIMS ANY IMPLIED WARRANTIES OF MERCHANTABILITY OR FITNESS FOR ANY PARTICULAR PURPOSE WITH REGARD TO ANY OF THE FOREGOING. TOSHIBA ASSUMES NO LIABILITY FOR ANY DAMAGES INCURRED DIRECTLY OR INDIRECTLY FROM ANY TECHNICAL OR TYPOGRAPHICAL ERRORS OR OMISSIONS CONTAINED HEREIN OR FOR DISCREPANCIES BETWEEN THE PRODUCT AND THE MANUAL. IN NO EVENT SHALL TOSHIBA BE LIABLE FOR ANY INCIDENTAL, CONSEQUENTIAL, SPECIAL, OR EXEMPLARY DAMAGES, WHETHER BASED ON TORT, CONTRACT OR OTHERWISE, ARISING OUT OF OR IN CONNECTION WITH THIS MANUAL OR ANY OTHER INFORMATION CONTAINED HEREIN OR THE USE THEREOF.**

Using the Remote

The buttons used for operating the TV are described here. For the HDMI® CEC remote control functions, see the "HDMI® CEC playback device (DVD player, etc.) control" section in the User's Guide.

NOTE The error message "NOT AVAILABLE" may appear if you press a button for a function that is not available.

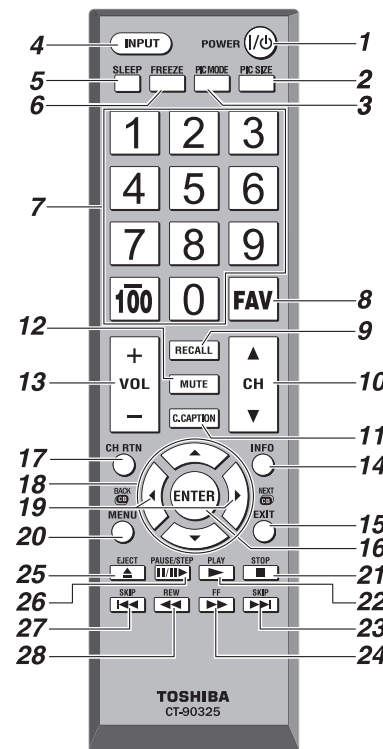

(Sample Illustration) Remote control overview

| Item: | Description: | Function: |
|-------|------------------------------|--|
| 1 | POWER button | Turns the TV On and Off. When the TV is on, the power LED indicator on the TV front glows green. |
| 2 | PIC SIZE button | Cycles through the picture sizes, see the "Selecting the picture size" section in the User's Guide. |
| 3 | PIC MODE button | Selects the picture mode, see the "Selecting the picture mode" section in the User's Guide. |
| 4 | INPUT button | Selects the video input source, see the "Selecting the video input source" section in the User's Guide. |
| 5 | SLEEP button | Accesses the sleep timer, see the "Setting the sleep timer" section in the User's Guide. |
| 6 | FREEZE button | Freezes the picture. Press again to restore the moving picture, see the "Using the FREEZE feature" section in the User's Guide. |
| 7 | Channel Number buttons (0-9) | Directly tunes channels. The 100 button allows you to enter two part channel numbers, see the "Storing channels in memory (optional)" section, or to edit the Favorites List, see the "Favorites browser" section in the User's Guide. |
| 8 | FAV button | Accesses the Favorites List in the Channel Browser, see the "Favorites browser" section in the User's Guide. |
| 9 | RECALL button | Displays TV status information. |
| 10 | CH (▲/▼) buttons | Cycles through programmed channels. |
| 11 | C. CAPTION button | Accesses closed captions, see the "Using closed captions" section in the User's Guide. |
| 12 | MUTE button | Reduces or turns off the sound, see the "Muting the sound" section in the User's Guide. |
| 13 | VOL (+/-) buttons | Adjusts the volume level. |
| 14 | INFO button | Displays TV status information as well as program details, when available, see the "Displaying TV information" section in the User's Guide. |
| 15 | EXIT button | Closes on-screen menus. |
| 16 | ENTER button | Activates highlighted items in the main menu system. |
| 17 | CH RTN button | Returns to the last viewed channel or source, see the "Switching between two channels using Channel Return" section in the User's Guide. |
| 18 | (▲/▼/◀/▶) buttons | Selects or adjusts programming menus when a menu is on-screen. |
| 19 | (◀/▶) buttons | Opens the Channel Browser and tunes to the previous/next channel in the channel history when TV programming is on-screen. See the "Tuning channels using the Channel Browser" section in the User's Guide. |
| 20 | MENU button | Accesses the main TV menu system. See the "Navigating the menu system" section in the User's Guide. |
| 21-28 | Playback buttons | Controls HDMI® CEC compatible devices. See "Learning about the remote control" section in the User's Guide. |

Connecting your TV

For detailed information, see the "Connecting your TV" section in the User's Guide located at support.toshiba.com.

Connecting an HDMI® or DVI device to the HDMI® input

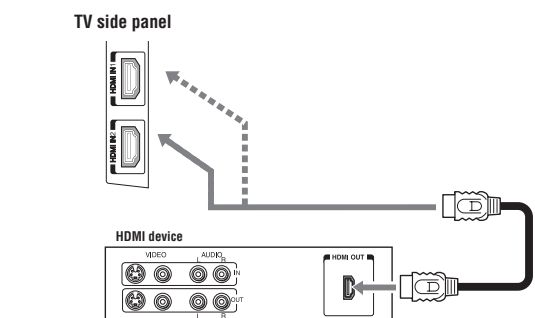

(Sample Illustration) Connecting an HDMI® device

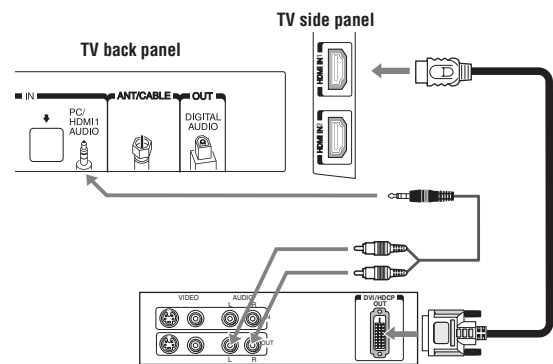

(Sample Illustration) DVI connections

Connecting a digital audio system

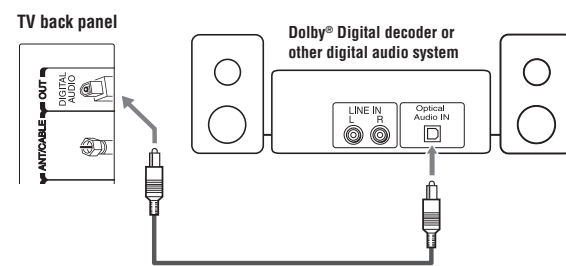

(Sample Illustration) Connecting a digital audio system

Connecting a computer

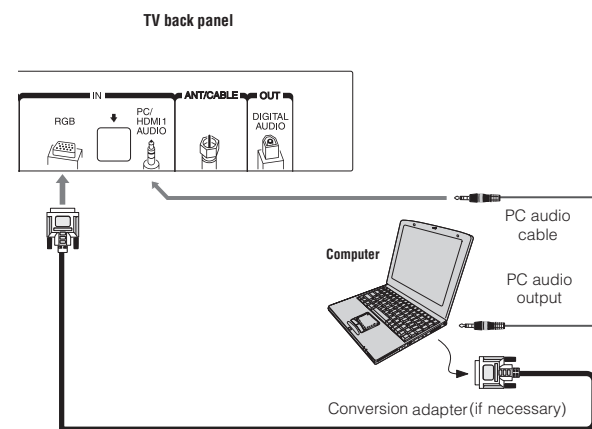

(Sample Illustration) Connecting a computer

Connecting a VCR, antenna, cable TV, or camcorder

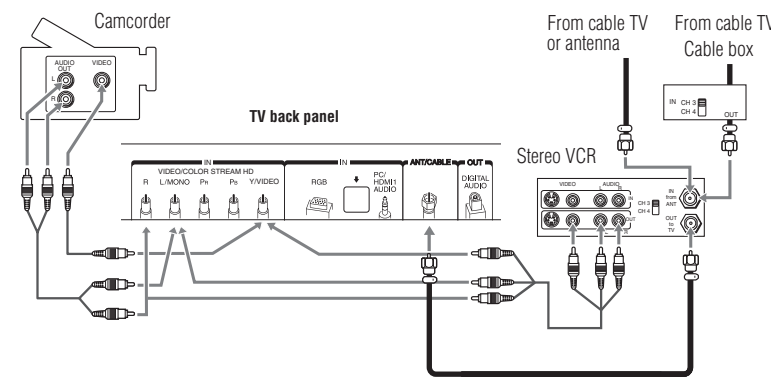

(Sample Illustration) Connecting to a VCR, antenna, or cable TV or camcorder

Connecting HDMI® CEC devices

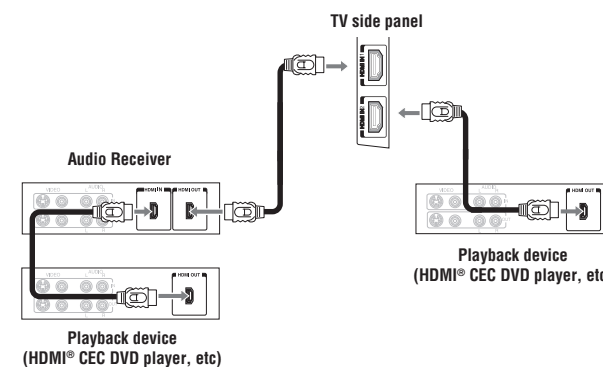

(Sample Illustration) Connecting HDMI® CEC compatible audio receiver and playback device connections

Connecting a Blu-ray™/DVD player, satellite receiver, or VCR with ColorStream®

NOTE ColorStream® and composite video cannot be used simultaneously.

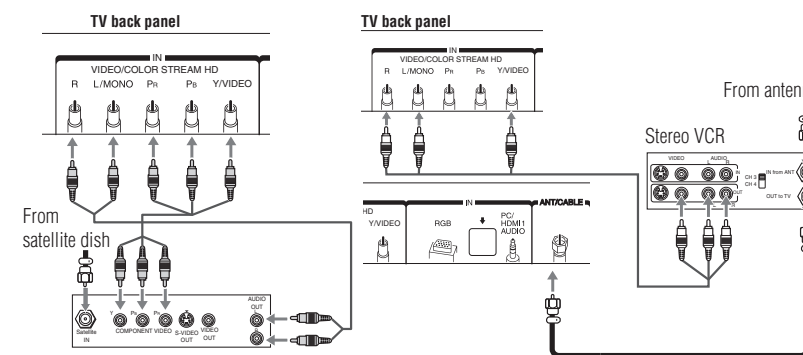

(Sample Illustration) Connecting a Blu-ray™/DVD player, satellite receiver, or VCR with ColorStream®

Troubleshooting

Refer to the "Troubleshooting" chapter in the online User's Guide at support.toshiba.com. If you are still having trouble you may need to contact Toshiba for additional assistance.

Toshiba Support

If you require help or are having problems operating your product, contact Toshiba at:
Toshiba's Support Web site: support.toshiba.com.
For technical support, call the Toshiba Customer Support Center:
Within the United States at (800) 631-3811
Outside the United States at (949) 583-3050