

TOSHIBA

Leading Innovation >>>

Owner's Manual

Integrated High Definition LCD TV/DVD Combination



19SLV411U
24SLV411U
32SLV411U

For an overview of steps for setting up your new TV, see page 11.

Note: To display a High Definition picture, the TV must be receiving a High Definition signal (such as an over-the-air High Definition TV broadcast, a High Definition digital cable program, or a High Definition digital satellite program). For details, please contact your TV antenna installer, cable provider, or satellite provider.

Owner's Record

The model number and serial number are on the back of your LCD TV / DVD combination. Record these numbers in the spaces below. Refer to these numbers whenever you communicate with your Toshiba dealer about this LCD TV / DVD combination.

Model number:

Serial number:



Dear Customer,

Thank you for purchasing this Toshiba LCD TV / DVD combination. This manual will help you use the many exciting features of your new LCD TV / DVD combination. **Before operating your LCD TV / DVD combination, please read this manual completely, and keep it nearby for future reference.**

Safety Precautions

WARNING: TO REDUCE THE RISK OF FIRE OR ELECTRIC SHOCK, DO NOT EXPOSE THIS APPLIANCE TO RAIN OR MOISTURE.



WARNING
RISK OF ELECTRIC
SHOCK DO NOT OPEN.



WARNING: TO REDUCE THE RISK OF ELECTRIC SHOCK, DO NOT REMOVE COVER (OR BACK). NO USER-SERVICEABLE PARTS INSIDE. REFER SERVICING TO QUALIFIED SERVICE PERSONNEL.



The lightning flash with arrowhead symbol, within an equilateral triangle, is intended to alert the user to the presence of uninsulated "dangerous voltage" within the product's enclosure that may be of sufficient magnitude to constitute a risk of electric shock to persons.



The exclamation point within an equilateral triangle is intended to alert the user to the presence of important operating and maintenance (servicing) instructions in the literature accompanying the appliance.

WARNING

To prevent injury, this apparatus must be securely attached to the floor/wall in accordance with the installation instructions. See item 25 on page 4.

WARNING: If you decide to wall mount this television, always use a UL Listed wall bracket appropriate for the size and weight of this television. The use of any wall bracket other than a UL Listed wall bracket appropriate for the size and weight of this television for wall mounting this television could result in serious bodily injury and/or property damage. See "Removing the Pedestal Stand" (page 6).

NOTE TO CATV INSTALLERS

This is a reminder to call the CATV system installer's attention to Article 820-40 of the U.S. NEC, which provides guidelines for proper grounding and, in particular, specifies that the cable ground shall be connected to the grounding system of the building, as close to the point of cable entry as practical. For additional antenna grounding information, see items 32 and 33 on page 4.

CHILD SAFETY:

It Makes A Difference How and Where You Use Your Flat Panel Display

Congratulations on your purchase! As you enjoy your new product, please keep these safety tips in mind:

The Issue

• The home theater entertainment experience is a growing trend and larger flat panel displays are popular purchases. However, flat panel displays are not always supported on the proper stands or installed according to the manufacturer's recommendations.

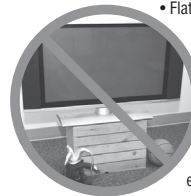

• Flat panel displays that are inappropriately situated on dressers, bookcases, shelves, desks, speakers, chests or carts may fall over and cause injury.

TOSHIBA Cares!

• The consumer electronics industry is committed to making home entertainment enjoyable and safe.

Tune Into Safety

- One size does NOT fit all. Follow the manufacturer's recommendations for the safe installation and use of your flat panel display.
- Carefully read and understand all enclosed instructions for proper use of this product.
- Don't allow children to climb on or play with furniture and television sets.
- Don't place flat panel displays on furniture that can easily be used as steps, such as a chest of drawers.
- Remember that children can become excited while watching a program, especially on a "larger than life" flat panel display. Care should be taken to place or install the display where it cannot be pushed, pulled over, or knocked down.
- Care should be taken to route all cords and cables connected to the flat panel display so that they cannot be pulled or grabbed by curious children.

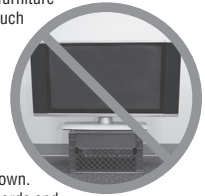



Wall Mounting: If you decide to wall mount your flat panel display, always:

- Use a mount that has been recommended by the display manufacturer and/or listed by an independent laboratory (such as UL, CSA, ETL).
- Follow all instructions supplied by the display and wall mount manufacturers.
- If you have any doubts about your ability to safely install your flat panel display, contact your retailer about professional installation.
- Make sure that the wall where you are mounting the display is appropriate. Some wall mounts are not designed to be mounted to walls with steel studs or old cinder block construction. If you are unsure, contact a professional installer.
- A minimum of two people are required for installation. Flat panel displays can be heavy.

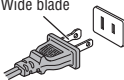

www.CE.org/safety

Important Safety Instructions

- 1) **Read these instructions.**
 - 2) **Keep these instructions.**
 - 3) **Heed all warnings.**
 - 4) **Follow all instructions.**
-
- 5) **Do not use this apparatus near water.**
-
- 6) **Clean only with dry cloth.**
-
- 7) **Do not block any ventilation openings.** Install in accordance with the manufacturer's instructions.
-
- 8) **Do not install near any heat sources** such as radiators, heat registers, stoves, or other apparatus (including amplifiers) that produce heat.
-
- 9) **Do not defeat the safety purpose of the polarized or grounding type plug.** A polarized plug has two blades with one wider  than the other. A grounding type plug has two blades and a third grounding prong. The wide blade or the third prong are provided for your safety. If the provided plug does not fit into your outlet, consult an electrician for replacement of the obsolete outlet.
-
- 10) **Protect the power cord** from being walked on or pinched, particularly at plugs, convenience receptacles, and the point where they exit from the apparatus. 
-
- 11) **Only use attachments/accessories specified by the manufacturer.**
-
- 12) **Use only with the cart, stand, tripod, bracket, or table specified by the manufacturer, or sold with the apparatus.** When a cart is used, use caution when moving the cart/apparatus combination to avoid injury from tip-over. 
-
- 13) **Unplug this apparatus during lightning storms or when unused for long periods of time.**
-
- 14) **Refer all servicing to qualified service personnel.** Servicing is required when the apparatus has been damaged in any way, such as power-supply cord or plug is damaged, liquid has been spilled or objects have fallen into the apparatus, the apparatus has been exposed to rain or moisture, does not operate normally, or has been dropped.



- ALWAYS turn off the TV and unplug the power cord to avoid possible electric shock or fire.
- NEVER allow your body to come in contact with any broken glass or liquid from the damaged television. The LCD panel inside the TV contains glass and a toxic liquid. If the liquid comes in contact with your mouth or eyes, or your skin is cut by broken glass, rinse the affected area thoroughly with water and consult your doctor.
- ALWAYS contact a service technician to inspect the TV any time it has been damaged or dropped.

- 15) **CAUTION:**
 - To reduce the risk of electric shock, do not use the polarized plug with an extension cord, receptacle, or other outlet unless the blades can be inserted completely to prevent blade exposure.
 - To prevent electric shock, match wide blade of plug to wide slot; fully insert.
-
- 16) **CAUTION:**

Do not let children swallow the product or play with the plastic bag. Keep the product and the plastic bag out of the reach of children.

- 17) **CAUTION:**

Do not let water or other liquids come into contact with the product, as it may result in damage.
-
- 18) **WARNING:**
 - To prevent the spread of fire, keep candles or other open flames away from this product at all times.
 - Keep the product away from direct sunlight, fire or a heat source such as a heater. This may reduce the product lifetime or result in fire.
 - The mains plug is used as the disconnect device, and therefore install the LCD TV / DVD combination near the wall outlet so that the mains plug can be accessed easily at all times.

Installation, Care, and Service

Installation

Follow these recommendations and precautions and heed all warnings when installing your TV:

- 19)  **WARNING: NEVER expose batteries to excessive heat such as sunshine, fire or the like.**
- 20) ALWAYS plug the product into an outlet that is located in such a manner that it can be easily unplugged in case the product requires service.
- 21) NEVER route the product's power cord inside a wall or similar enclosed area.
- 22) Never modify this equipment. Changes or modifications may void: a) the warranty, and b) the user's authority to operate this equipment under the rules of the Federal Communications Commission.

Additional Safety Precautions

- 14a) **CAUTION:** If the TV is dropped and the cabinet or enclosure surface has been damaged or the TV does not operate normally, take the following precautions:

(continued)

- 23)  **DANGER: RISK OF SERIOUS PERSONAL INJURY, DEATH, OR EQUIPMENT DAMAGE!**

Never place the TV on an unstable cart, stand, or table. The TV may fall, causing serious personal injury, death, or serious damage to the TV.



- 24) To avoid damage to this product, never place or store the TV in direct sunlight; hot, humid areas; or areas subject to excessive dust or vibration.

- 25) Always place the TV on the floor or a sturdy, level, stable surface that can support the weight of the TV. In order to maintain stability and prevent the TV falling over, secure the TV with a sturdy strap from the hook on the rear of the TV pedestal to a wall stud, pillar, or other immovable structure. Make sure the strap is tight, secure, and parallel to the floor.

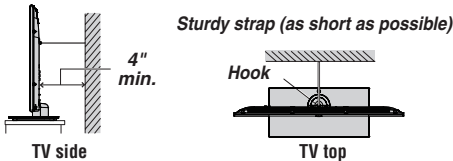

(The sturdy tie and hook is applicable to 32SLV411U.)

- 26) The apparatus shall not be exposed to dripping or splashing, and no objects filled with liquids, such as vases, shall be placed on the apparatus.
- 27) Never block or cover the slots or openings in the TV cabinet back, bottom, and sides. Never place the TV:
- on a bed, sofa, rug, or similar surface;
 - too close to drapes, curtains, or walls; or
 - in a confined space such as a bookcase, built-in cabinet, or any other place with poor ventilation.

The slots and openings are provided to protect the TV from overheating and to help maintain reliable operation of the TV. Leave a space of at least 4 (four) inches around the TV.



- 28) Always place the back of the television at least 4 (four) inches away from any vertical surface (such as a wall) to allow proper ventilation.
- 29) Never allow anything to rest on or roll over the power cord, and never place the TV where the power cord is subject to wear or abuse.
- 30) Never overload wall outlets and extension cords.
- 31) Always operate this equipment from a 120 VAC, 60 Hz power source only.
- 32) Always make sure the antenna system is properly grounded to provide adequate protection against voltage surges and built-up static charges (see Section 810 of the National Electric Code).

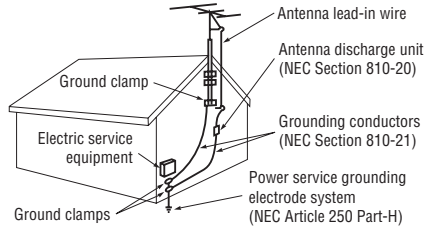

- 33)  **DANGER: RISK OF SERIOUS PERSONAL INJURY OR DEATH!**

- Use extreme care to make sure you are never in a position where your body (or any item you are in contact with, such as a ladder or screwdriver) can accidentally touch overhead power lines. Never locate the antenna near overhead power lines or other electrical circuits.
- Never attempt to install any of the following during lightning activity: a) an antenna system; or b) cables, wires, or any home theater component connected to an antenna or phone system.



Care

For better performance and safer operation of your TOSHIBA LCD TV / DVD combination, follow these recommendations and precautions:

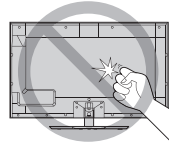

- 34) If you use the TV in a room whose temperature is 32 °F (0 °C) or below, the picture brightness may vary until the LCD warms up. This is not a sign of malfunction.
- 35) Always unplug the TV before cleaning. When cleaning your TV, please first remove any dirt or dust from the surface. Gently wipe the cabinet and the display panel surface (the TV screen) with a dry, soft cloth only (cotton, flannel, etc.). The enclosed cleaning cloth is for cabinet cleaning. Harsh rubbing or use of a dirty or stiff cloth will scratch the TV surface. Avoid contact with alcohol, thinner, benzene, acidic or alkaline solvent cleaners, abrasive cleaners, or chemical cloths, which may damage the TV surface. Never spray volatile compounds such as insecticide on the TV surface. Such products may damage or discolor the TV.
- 36) Never hit, press, or place anything on the back cover. These actions will damage internal parts.



(continued)



- 37)  **WARNING: RISK OF ELECTRIC SHOCK!** 
Never spill liquids or push objects of any kind into the TV cabinet slots.

- 38) While it is thundering, do not touch the connecting cables or apparatus.
- 39) For added protection of your TV from lightning and power surges, always unplug the power cord and disconnect the antenna from the TV if you leave the TV unattended or unused for long periods of time.
- 40) ALWAYS unplug the TV to completely disconnect from mains power. When the TV is turned off using the on/off switch, it is not completely disconnected from power and a minute amount of current is still consumed.
- 41) During normal use, the TV may make occasional snapping or popping sounds. This is normal, especially when the unit is being turned on or off. If these sounds become frequent or continuous, unplug the power cord and contact a Toshiba Authorized Service Provider.

- 42)  **WARNING: RISK OF SERIOUS PERSONAL INJURY OR EQUIPMENT DAMAGE!** Never strike the screen with a sharp or heavy object. 

- 43) • The LCD screen of this product can be damaged by ultraviolet radiation from the sun. When selecting a location for the television, avoid locations where the screen may be exposed to direct sunlight, such as in front of a window.
- Never touch, press, or place anything on the LCD screen. These actions will damage the LCD screen. If you need to clean the LCD screen, follow the instructions in item 35 on page 4.

Service

- 44)  **WARNING: RISK OF ELECTRIC SHOCK!** 
Never attempt to service the TV yourself. Opening and removing the covers may expose you to dangerous voltage or other hazards. Failure to follow this WARNING may result in death or serious injury. Refer all servicing not specified in this manual to a Toshiba Authorized Service Provider.

- 45) If you have the TV serviced:
- Ask the service technician to use only replacement parts specified by the manufacturer.

- Upon completion of service, ask the service technician to perform routine safety checks to determine that the TV is in safe operating condition.

Choosing a location for your LCD TV / DVD combination

To Display your LCD TV / DVD combination on the included Pedestal Stand:

Observe the following safety precautions:

- 1) Read and Follow the pedestal assembly instructions included with the pedestal.
CAUTION: Before beginning pedestal assembly, carefully lay the front of the LCD Panel face down on a flat, cushioned surface such as a quilt or blanket. Leave the bottom of the unit protruding over the edge of the surface and assemble the pedestal as indicated below.
Note: *Extreme care should always be used when attaching the pedestal stand to avoid damage to the LCD panel.*
- 2) Place the TV on a sturdy, level surface that can support the weight of the TV.
- 3) Be sure to secure the TV to a wall, pillar, surface, or other immovable structure. (☞ item 25, page 4).

To Display your LCD TV / DVD combination using a Wall Bracket:

If you decide to wall mount your LCD TV / DVD combination, always use a UL listed wall bracket appropriate for the size and weight of the LCD TV / DVD combination (☞ page 2):

- 1) **CAUTION:** Two people are required for installation.
- 2) Unplug and remove any cables and/or other component connectors from the rear of the TV.
- 3) Follow the instructions provided with your wall bracket. Before proceeding, make sure the appropriate bracket(s) are attached to the wall and the back of the TV as described in the instructions provided with the wall bracket.
- 4) **IMPORTANT:** Always use the screws supplied or recommended by the wall mount manufacturer.
- 5) After attaching the appropriate bracket(s) to the wall and the back of the TV, remove the pedestal stand from the TV as described below.
- 6) VESA Mounting Pattern

TV Size	Hole Pattern(HxV)	Screw Size
19"	100x100 mm	M4
24"	100x100 mm	M4
32"	200x200 mm	M6

(unit in mm)

Removing the Pedestal Stand

- 1) Carefully lay the front of the TV face down on a flat, cushioned surface such as a quilt or blanket. Leave the stand protruding over the edge of the surface.
Note: *Extreme care should always be used when removing the pedestal stand to avoid damage to the LCD panel.*
- 2) Remove the four screws shown in the below diagram. This will allow removal of the pedestal stand.
- 3) Once you have removed all four screws, holding the pedestal stand in place, remove the pedestal stand from the TV.

19SLV411U VESA Mounting Pattern

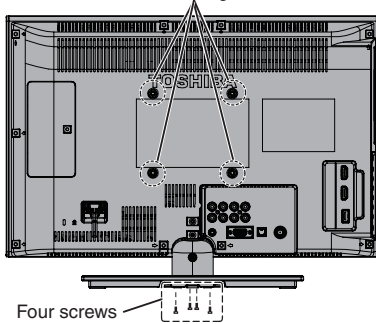

24SLV411U VESA Mounting Pattern

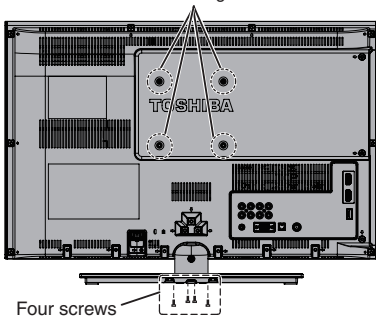

32SLV411U VESA Mounting Pattern

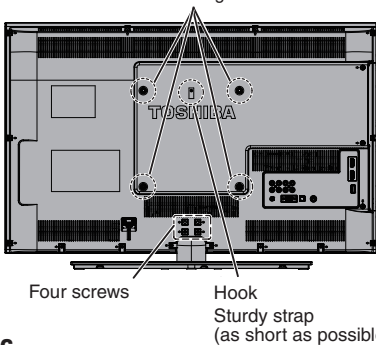

Hook
Sturdy strap
(as short as possible)

CAUTION: Always place the TV on the floor or a sturdy, level, stable surface that can support the weight of the unit. To secure the TV, use a sturdy strap from the hook(s) on the rear of the TV to a wall stud, pillar, or other immovable structure. Make sure the strap is tight, secure, and parallel to the floor.

Notes on moisture condensation

Moisture condensation damages the unit. Please read the following carefully.

Moisture condensation occurs, for example, when you pour a cold drink into a glass on a warm day and drops of water form on the outside of the glass. In the same way, moisture may condense on this unit's internal optical pick-up lens, one of the most crucial internal parts of the unit.

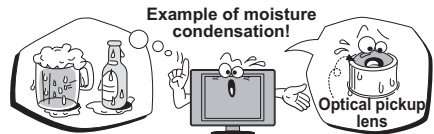

Moisture condensation may occur in the following situations:

- When you move the unit from a cold area to a warm area.
- When you use the unit in a room in which the heat was just turned on.
- When you use the unit in an area where cold air from an air conditioner directly hits the unit.
- When you use the unit in a humid area.



Never use the unit when moisture condensation may occur.

Using the unit when moisture condensation exists may damage discs and internal parts. Connect the power cord of the unit to the wall outlet, turn on the unit, remove the disc, and leave it for two or three hours. After two or three hours, the unit will have warmed up and evaporated any moisture. Leaving the TV connected to the wall outlet will help prevent moisture condensation in the unit.

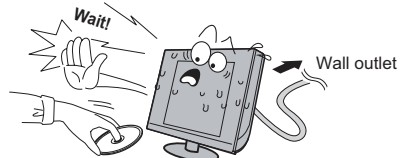

Notes on discs

On handling discs

- Do not touch the playback side of the disc. Handle the disc as shown in the figure below.

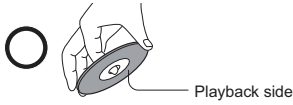

- Do not attach paper or tape to discs.



On cleaning discs

- Fingerprints and dust on the disc cause picture and sound deterioration. Wipe the disc from the center outwards with a soft cloth. Always keep the disc clean.



- Do not use any type of solvent such as thinner, benzene, commercially available cleaners or antistatic spray for vinyl LPs. It may damage the disc.

On storing discs

- Do not store discs in a place subject to direct sunlight or near heat sources.
- Do not store discs in places subject to moisture and dust such as a bathroom or near a humidifier.
- Store discs vertically in a case. Stacking or placing objects on discs outside of their case may cause warping.

Structure of disc contents

Normally, DVD video discs are divided into titles, and the titles are sub-divided into chapters. Video CDs and Audio CDs are divided into tracks.

DVD

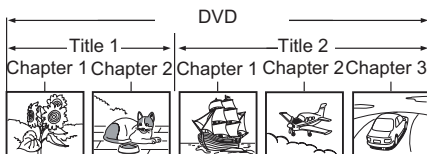

Video CD/Audio CD

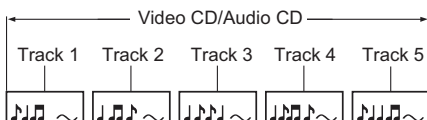

Each title, chapter or track is assigned a number, which is called "title number", "chapter number" or "track number" respectively. There may be discs that do not have these numbers.

Notes on copyright

The unauthorized recording, use, distribution, or revision of copyrighted materials including, without limitation, television programs, videotapes, and DVDs, is prohibited under the Copyright Laws of the United States and other countries, and may subject you to civil and criminal liability.

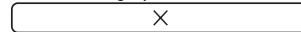

About this owner's manual

This owner's manual explains the basic instructions of this LCD TV / DVD combination. Some DVD video discs are produced in a manner that allows specific or limited operation during playback. As such, the LCD TV / DVD combination may not respond to all operating command. This is not a defect of the LCD TV / DVD combination. Refer to the instruction notes of discs. The following symbol may appear on the TV screen during operation.



It means that the operation is not permitted by the LCD TV / DVD combination or the disc. For example, sometimes it is unable to stop the playback of copyright message of the disc when the Stop button is pressed. Alternatively, this symbol may also indicate that the feature is not available for the disc.

Notes on region numbers

The region number of this LCD TV / DVD combination is 1. If region numbers, which stand for their playable area, are printed on your DVD and you do not find  or , disc playback will not be allowed by the player. (In this case, the LCD TV / DVD combination will display a message on-screen.). Some DVDs that have no region code label may still be subject to area restrictions and therefore not playable.

On Video CDs

This LCD TV / DVD combination supports Video CDs equipped with the Playback Control (PBC) function, version 2.0. You can enjoy two playback variations depending on types of discs.

• Video CD not equipped with PBC function (Version 1.1)

Sound and movie can be played on this LCD TV / DVD combination in the same way as a DVD.

• Video CD equipped with PBC function (Version 2.0)

In addition to operation of a Video CD not equipped with the PBC function, you can enjoy playback of interactive software with search function by using the on-screen playback menu. Some of the functions described in this owner's manual may not work with some discs.

Playable discs

This LCD TV / DVD combination can play the following discs.

	Disc mark	Contents	Disc size	Maximum playback time
DVD Video disc		Audio + Video (moving pictures)	12 cm	Approx. 4 hours (single sided disc)
			8 cm	Approx. 8 hours (double sided disc)
Video CD		Audio + Video (moving pictures)	12 cm	Approx. 80 minutes (single sided disc)
			8 cm	Approx. 160 minutes (double sided disc)
Audio CD		Audio	12 cm	Approx. 74 minutes (single sided disc)
			8 cm	Approx. 20 minutes (single sided disc)

The following discs are also supported.

- DVD-R/RW discs containing files of DVD video format.
- CD-R/CD-RW discs containing CD-DA, Video CD, MP3, WMA, or JPEG files.
- Kodak Picture CD and FUJICOLOR CD.

Some of these discs may be incompatible.

- You cannot play discs other than those listed above.
- You cannot play discs of DVD-RAM, DVD-ROM, CD-ROM, Photo CD, etc., or non-standardized discs even if they may be labeled as above.
- Some CD-R/RWs cannot be played back depending on the recording conditions.
- This LCD TV / DVD combination uses the NTSC color system, and cannot play DVD video discs recorded in any other color system (PAL, SECAM, etc.).
- This LCD TV / DVD combination can play an 8 cm disc. Please do not use a disc adapter. It may cause trouble.
- Please do not insert any disc of an irregular shape into the LCD TV / DVD combination, as it may interfere with the function of the LCD TV / DVD combination. You may not be able to remove it.
- Please do not use after market accessories, such as a ring protector, as this may cause trouble with the operation of the LCD TV / DVD combination.

Because of problems and errors that can occur during the creation of DVD and CD software and/or the manufacture of DVD and CD discs, Toshiba cannot assure that this LCD TV / DVD combination will successfully play every disc bearing the DVD and CD logos. If you happen to experience any difficulty playing a DVD or CD on this LCD TV / DVD combination, please contact Toshiba Customer Service.

 is a trademark of DVD Format / Logo Licensing Corporation.

FCC Declaration of Conformity Compliance Statement (Part 15):

The **Toshiba 19SLV411U, 24SLV411U and 32SLV411U LCD TV / DVD combinations** comply with Part 15 of the FCC rules. Operation is subject to the following two conditions: (1) this device may not cause harmful interference, and (2) this device must accept any interference received, including interference that may cause undesired operation.

The party responsible for compliance to these rules is:

Toshiba America Information Systems, Inc.
9740 Irvine Blvd.; Irvine, CA 92618
Ph: 1-800-631-3811

Note: *This equipment has been tested and found to comply with the limits for a Class B digital device, pursuant to Part 15 of the FCC rules. These limits are designed to provide reasonable protection against harmful interference in a residential installation. This equipment generates, uses, and can radiate radio frequency energy and, if not installed and used in accordance with the instructions, may cause harmful interference to radio communications. However, there is no guarantee that interference will not occur in a particular installation. If this equipment does cause harmful interference to radio or television reception, which can be determined by removing and applying power to the equipment, the user is encouraged to try to correct the interference by one or more of the following measures:*

- Reorient or relocate the receiving antenna.
- Increase the separation between the equipment and the receiver.
- Connect the equipment into an outlet on a circuit different from that to which the receiver is connected.
- Consult the dealer or an experienced radio/TV technician for help.

Caution: *Changes or modifications to this equipment not expressly approved by Toshiba could void the user's authority to operate this equipment.*

ENERGY STAR® User Information (only for 19/24")

ENERGY STAR User Information Statement: the factory default settings of this television meet ENERGY STAR requirements. Changing Picture Settings may increase energy consumption, possibly beyond the limits required for ENERGY STAR qualification.

To ensure your television is operating at optimal energy efficiency, select [Home] mode during initial activation. To return to [Home] mode settings, select [Standard] picture mode. [Standard] mode is recommended for normal home use. (E6 page 26)

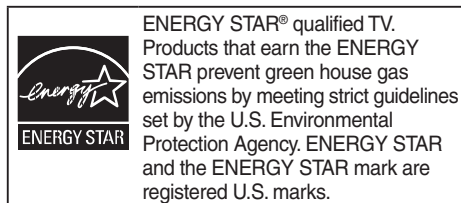

Note: Model 32SLV411U is not ENERGY STAR® qualified.

Important notes about your LCD TV / DVD combination

The following symptoms are technical limitations of LCD Display technology and are not an indication of malfunction; therefore, Toshiba is not responsible for perceived issues resulting from these symptoms.

- 1) An afterimage (ghost) may appear on the screen if a fixed, nonmoving image is displayed for a long period of time. The afterimage is not permanent and will disappear in a short period of time.
- 2) The LCD panel contained in this TV is manufactured using an extremely high level of precision technology; however, there may be an occasional pixel (dot of light) that does not operate properly (does not light, remains constantly lit, etc.). This is a structural property of LCD technology, is not a sign of malfunction, and is not covered under your warranty. Such pixels are not visible when the picture is viewed from a normal viewing distance.

Note: Interactive video games that involve shooting a "gun" type of joystick at an on-screen target may not work with this TV.



Location of the required Marking

The rating sheet and the safety caution are on the rear of the unit.

CERTIFICATION: COMPLIES WITH FDA PERFORMANCE STANDARDS FOR LASER PRODUCTS EXCEPT FOR DEVIATIONS PURSUANT TO LASER NOTICE NO.50, DATED JUNE 24, 2007.

CAUTIONS:

- THIS LCD TV / DVD COMBINATION EMPLOYS A LASER SYSTEM.
- TO ENSURE PROPER USE OF THIS PRODUCT, PLEASE READ THIS OWNER'S MANUAL CAREFULLY AND RETAIN IT FOR FUTURE REFERENCE.
- SHOULD THE UNIT REQUIRE MAINTENANCE, CONTACT AN AUTHORIZED SERVICE LOCATION.
- USE OF CONTROLS, ADJUSTMENTS OR THE PERFORMANCE OF PROCEDURES OTHER THAN THOSE SPECIFIED HEREIN MAY RESULT IN HAZARDOUS RADIATION EXPOSURE.
- TO PREVENT DIRECT EXPOSURE TO LASER BEAM, NEVER OPEN THE ENCLOSURE. VISIBLE LASER RADIATION MAY BE PRESENT WHEN THE ENCLOSURE IS OPENED. NEVER STARE INTO THE BEAM.

Trademark Information

- Manufactured under license from Dolby Laboratories. Dolby and the double-D symbol are trademarks of Dolby Laboratories.
- HDMI, the HDMI logo and High-Definition Multimedia Interface are trademarks or registered trademarks of HDMI Licensing LLC in the United States and other countries.
- MPEG Layer-3 audio coding technology licensed from Fraunhofer IIS and Thomson.
- This production contains Bitstream Vera Sans fonts under the following copyright. Copyright © 2003 by Bitstream, Inc. All Rights Reserved. Bitstream Vera is a trademark of Bitstream, Inc.

Contents

Important Safety Instructions	3
Installation, Care, and Service	3
Choosing a location for your LCD TV / DVD combination	5
Notes on discs	7
Chapter 1: Introduction	11
Features of your new TV	11
Overview of steps for installing, setting up, and using your new TV	11
TV front, top and side panel controls and connections	12
TV back panel connections	13
Chapter 2: Connecting your TV	14
Overview of cable types	14
About the connection illustrations	14
Connecting TV to a power source	14
Connecting a VCR, and antenna, Cable TV	15
Connecting a camcorder	15
Connecting a DVD player with ColorStream® (component video)	16
Connecting a satellite receiver	16
Connecting an HDMI or DVI device to the HDMI® input	17
REGZA-LINK® connection	18
Connecting a digital audio system	19
Connecting a personal computer (PC)	20
Chapter 3: Using the remote control	21
Preparing the remote control for use	21
Installing the remote control batteries	21
Learning about the remote control	22
Chapter 4: Menu layout and navigation	24
Main menu layout	24
Setup / Installation menu layout	25
Navigating the menu system	25
Chapter 5: Setting up your TV	26
Initial Setup	26
Selecting the menu language	26
Configuring the antenna input source for the ANT/CABLE terminal	26
Programming channels into the TV's channel memory	26
Programming channels automatically	26
Setting channel skip	27
Setting the HDMI® audio mode	28
Viewing the digital signal meter	29
Setting the time zone	29
Viewing the system status	29
Reset Factory Defaults	29
Chapter 6: Using the TV's features	30
Selecting the video input source to view	30
Labeling the video input sources	30
Tuning channels	31
Tuning channels using the Channel Browser™	31
Setting the Channel Tuning Mode	33
Tuning to the next programmed channel	34
Tuning to a specific channel (programmed or unprogrammed)	34
Switching between two channels using Channel Return	34
Switching between two channels using SurfLock™	34
Selecting the picture size	34
Scrolling the TheaterWide® picture (TheaterWide 2 and 3 only)	36
Using the auto aspect ratio feature	36
Selecting the cinema mode	37
Using the FREEZE feature	37
Adjusting the picture	37
Selecting the picture mode	37
Adjusting the picture quality	38
Using the closed caption mode	38
Basic closed captions	38
Digital CC Settings	39
CC Selector	39
Adjusting the audio	39
Muting the sound (For TV speakers)	39
Using the digital audio selector	39
Selecting stereo / SAP broadcasts	40
Using the MTS button	40
Adjusting the audio quality	40
Selecting the optical audio output format	40
Using the Dolby® Digital Dynamic Range Control feature	41
Using the Locks menu	41
Entering the PIN code	41
If you cannot remember your PIN code	41
Changing your PIN code	41
Blocking TV programs and movies by rating (V-Chip)	41
Downloading an additional rating system for blocking TV programs and movies	42
Blocking TV programs by Canada rating	43
Unlocking programs temporarily	44
Using the input lock feature	44
Locking channels	44
Using the GameTimer®	44
Using the panel lock feature	45
Using the PC settings feature	45
Setting the PC Audio	45
Using the Media Player	46
Using the Media Player with USB	46
To select the Auto Start function	46
To open the Media Player	46
Viewing photo files	47
Single View	47
Slide Show	47
Playing music files	47
During playback	48
Viewing photo files with playing music files at the same time	48
Setting the sleep timer	49
Automatic Power Down	49
No Signal Power Down	49
Using REGZA-LINK®	50
REGZA-LINK® playback device (DVD player, etc.) control	50
REGZA-LINK® input source selection	50
VOLUME and MUTE controls of Audio Receiver	51
Other REGZA-LINK® functions	51
Displaying TV status information	52
Understanding the auto power off feature	52
Understanding the last mode memory feature	52
Chapter 7: Using the TV's advanced features	53
Using the advanced picture settings features	53
Using Dynamic Contrast	53
Using the Static Gamma feature	53
Selecting the Color Temperature	53
Using CableClear® digital Noise Reduction	54
Using MPEG Noise Reduction	54
Using the Game Mode feature	54
Chapter 8: Basic disc playback	55
Disc playback	55
Playback navigation	56
Playing in fast reverse or fast forward direction (DVD/VCD/CD)	56
Playing in frame by frame (DVD/VCD)	56
Playing in slow motion (DVD/VCD)	56
Locating a chapter or track (DVD/VCD/CD)	56
Chapter 9: Advanced disc playback	57
Zoom function/Scene navigation	57
Using Zoom (DVD/VCD)	57
Locating a specific scene	57
Scene bookmark	58
Bookmarking a scene (DVD/VCD/CD)	58
Viewing a scene bookmark (DVD/VCD/CD)	58
Repeat playback/A-B repeat	58
Enabling repeat playback (DVD/VCD)	58
Enabling A-B repeat mode (DVD/VCD/CD)	59
Programmed playback/Random playback	59
Programming the playback sequence (VCD)	59
Enabling random playback (VCD)	60
Scene angle/Title selection/DVD menu	60
Changing the scene angle (DVD)	60
Selecting a DVD title (DVD)	60
DVD menu (DVD)	60
Soundtrack language/Audio channel/Subtitle	61
Selecting a soundtrack language (DVD)	61
Selecting the audio channel (VCD)	61
Viewing subtitles (DVD)	61
Playback information/VCD playback control	61
Viewing the playback info (DVD/VCD)	61
Turning off the PBC function (VCD)	61
MP3, WMA, JPEG, and Audio CD operation	62
MP3/WMA/JPEG/Audio CD information (CD)	62
About the file browser (CD)	63
Playing an audio file (CD)	63
Viewing a JPEG file (CD)	64
Viewing a slide show (CD)	64
MP3, WMA, JPEG and Audio CD playback modes	65
Enabling repeat playback (CD)	65
Enabling random playback (CD)	65
Programming the playback sequence (CD)	66
Chapter 10: Customizing disc playback	67
Customizing disc playback	67
Chapter 11: Troubleshooting	72
General troubleshooting	72
LED Indication	73
Chapter 12: Appendix	74
Specifications	74
Acceptable signal formats for PC IN and HDMI terminals	75
Limited United States Warranty LCD TV/DVD Combination	76
Limited Canadian Warranty for Toshiba Brand Flat Panel Televisions	77

Features of your new TV

The following are just a few of the many exciting features of your new Toshiba widescreen, integrated HD, LCD TV / DVD combination:

- **Integrated digital tuning (8VSB ATSC and QAM)** eliminates the need for a separate digital converter set-top box (in most cases).
- 1366 x 768 output resolution. (19SLV411U, 32SLV411U)
- 1920 x 1080 output resolution. (24SLV411U)
- **Two HDMI**® digital, high-definition multimedia interfaces 1080p input support (☞ page 17).
- **One set of ColorStream**® **HD** high-resolution component video inputs (☞ page 16).
- **Digital Audio Out** optical audio connection with Dolby® Digital optical output format (☞ page 40).
- **CableClear**® digital picture Noise Reduction (☞ page 54).
- **PC IN (Analog RGB)** computer terminal (☞ page 20).
- **REGZA-LINK**® allows control of external devices from the TV remote via HDMI connection (☞ page 50).
- **Media Player** allows you to view your JPEG files and listen to MP3 music. (☞ page 46).
-  **ENERGY STAR**® qualified.

Overview of steps for installing, setting up, and using your new TV

Follow these steps to set up your TV and begin using its many exciting features.

- 1 Carefully read the important safety, installation, care, and service information. Keep this manual for future reference.
- 2 Observe the following when choosing a location for the TV:
 - Read “Important notes about your LCD TV / DVD combination” (☞ page 9).
 - Place the TV on the floor or a sturdy, level, stable surface that can support the weight of the unit. Secure the TV to a wall, pillar, or other immovable structure (☞ page 4).
 - Place the TV in a location where light does not reflect on the screen.
 - Place the TV far enough from walls and other objects to allow proper ventilation. Inadequate ventilation may cause overheating, which will damage the TV. THIS TYPE OF DAMAGE IS NOT COVERED UNDER THE TOSHIBA WARRANTY.
- 3 Do not plug in any power cords until AFTER you have connected all cables and devices to your TV.
- 4 BEFORE connecting cables or devices to the TV, learn the functions of the TV’s connections and controls (☞ pages 12–13).
- 5 Connect your other electronic device(s) to the TV (☞ pages 14–20).
- 6 Install the batteries in the remote control (☞ page 21).
- 7 See “Learning about the remote control” (☞ page 22) for an overview of the buttons on the remote control.
- 8 AFTER connecting all cables and devices, plug in the power cords for your TV and other devices. Then press **POWER** on the TV control panel or remote control to turn on the TV. If the TV stops responding to the controls on the remote control or TV control panel and you cannot turn the TV off or on, please unplug the power cords for a few seconds then re-plug to try again.
- 9 See “Menu layout and navigation” for a quick overview of navigating the TV’s menu system (☞ page 24).
- 10 Program channels into the TV’s channel memory (☞ page 26).
- 11 For details on using the TV’s features, see Chapters 6 and 7.
- 12 For details on disc playback, see Chapters 8 and 9.
- 13 For help, refer to the Troubleshooting Guide, Chapter 11.
- 14 For technical specifications and warranty information, see Chapter 12.
- 15 Enjoy your new TV!

TV front, top and side panel controls and connections

19SLV411U / 24SLV411U / 32SLV411U

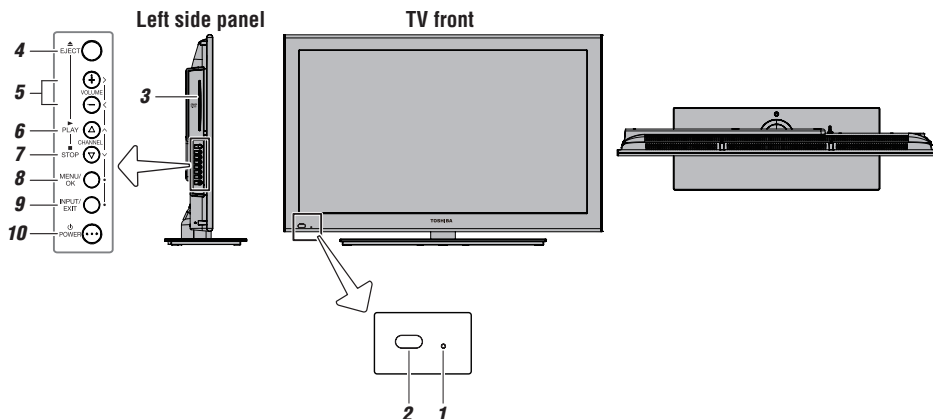

- 1 **Power On / Standby LED** — Power LED (Green) = Power indicator
Power LED (Red) = Power standby
- 2 **Remote sensor (embedded)** — Point the remote control toward this remote sensor.
Effective range:

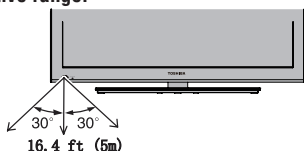

- 3 **Disc slot** — Load the disc, with label facing forward, into the disc slot to view or listen.
- 4 **EJECT** — Press to eject the disc.
- 5 **VOLUME +/-** — These buttons adjust the volume level. When a menu is on-screen, these buttons function as left/right menu navigation buttons.
- 6 **PLAY ► / CHANNEL ▲** — Press to play the disc in DVD mode; press to change the channel in TV mode.
ARROW ▲ — When a menu is on-screen, the button functions as up menu navigation button.
- 7 **STOP ■ / CHANNEL ▼** — Press to stop the disc playback in DVD mode; press to change the channel in TV mode.
ARROW ▼ — When a menu is on-screen, the button functions as down menu navigation button.
- 8 **MENU (OK)** — Press to access the menu system (see page 25). When a menu is on-screen, the MENU button on the TV's control panel functions as the **OK** button.

- 9 **INPUT / EXIT** — Repeatedly press to change the source you are viewing. When a menu is on-screen, the INPUT button on the TV's control panel functions as the EXIT button.
- 10 **POWER** — Press to turn the TV on and off. If the TV stops responding to the controls on the remote control or TV control panel and you cannot turn off the TV, press and hold the POWER button on the TV control panel for 5 or more seconds to reset the TV.

Note: 32SLV411U is used for illustration purposes.

Adjusting the screen angle (Applicable to 19SLV411U/24SLV411U)

You can adjust the angle of the TV screen 3° forward or 15° backward from a vertical angle. Hold the base of the TV while adjusting the screen.

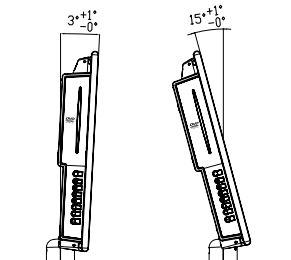

Some illustrations in this owner's manual are for explanation purposes and may differ from the actual unit.

TV back panel connections

For an explanation of cable types and connections see pages 14-20.

19SLV411U

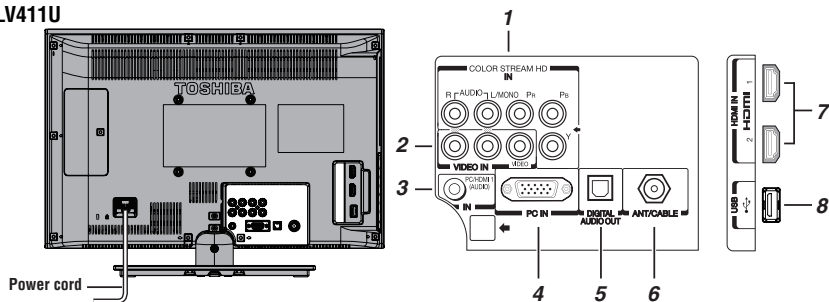

32SLV411U (Please use this illustration for 24SLV411U model.)

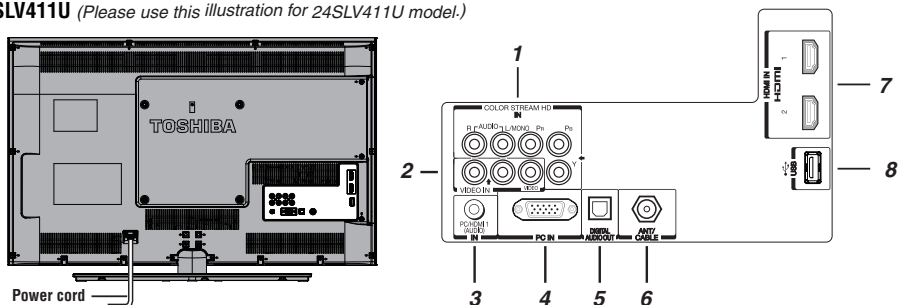

1 AUDIO/COLOR STREAM HD — ColorStream® high-definition component video inputs (with standard stereo audio inputs) for connecting devices with component video output, such as a Toshiba DVD player with ColorStream®.

Note: Component video cables carry only video information; separate audio cables are required for a complete connection.

2 AUDIO/VIDEO — Standard (composite) video and standard audio inputs (with standard A/V cables) for connecting devices with composite video.

Note: Standard (composite) video cables carry only video information; separate audio cables are required for a complete connection.

3 PC/HDMI1(Audio) IN — PC audio input terminal is shared with HDMI 1 analog audio input terminal, and its use can be configured in the **Audio Setup** menu (see page 45).

4 PC IN — For use when connecting a personal computer.

5 DIGITAL AUDIO OUT — Optical audio output in Dolby Digital or PCM (Pulse-Code Modulation) format for connecting an external Dolby Digital decoder, amplifier, or home theater system with optical audio input.

6 ANT/CABLE — Input that supports analog (NTSC) / digital (ATSC) off-air antenna signals and analog / digital Cable TV (QAM) signals.

7 HDMI IN — High-Definition Multimedia Interface input receives digital audio and uncompressed digital video from an HDMI device or uncompressed digital video from a DVI device. HDMI connection is necessary to receive 1080p signals.

8 USB port — To access JPEG or MP3 files.

Note: 19SLV411U and 32SLV411U are used for illustration purposes.

Overview of cable types

Cables can be purchased from most stores that sell audio/video devices. Before purchasing any cables, be sure of connector types required by your devices and the length of each cable.

Coaxial (F-type) cable



Coaxial (F-type) cable is used for connecting your antenna, cable TV service, and/or cable converter box to the **TUNER** input on your TV.

Standard A/V cables (red/white/yellow)



Standard A/V cables (composite video) usually come in sets of three, and are for use with video devices with analog audio and composite video output. These cables (and the related inputs on your TV) are typically color-coded according to use: yellow for video, red for stereo right audio, and white for stereo left (or mono) audio.

Component video cables (red/green/blue)



Component video cables come in sets of three and are for use with video devices with component video output. (ColorStream® is Toshiba's brand of component video.) These cables are typically color-coded red, green, and blue. Separate audio cables are required for a complete connection.

Note: Component video cables provide better picture performance than a standard (composite) video.

HDMI® cable (with HDMI Logo “**TM**”)



HDMI (High-Definition Multimedia Interface) cable is for use with devices with an HDMI output. An HDMI cable delivers digital audio and video in its native format. This cable carries both video and audio information; therefore, separate audio cables are not required for a complete HDMI device connection (☞ page 17, 18 and page 20).

Note: An HDMI cable provides the best audio and picture performance.

Optical audio cable



Optical audio cable is for connecting receivers with Dolby Digital or PCM (Pulse-Code Modulation) optical audio input to the TV's **DIGITAL AUDIO OUT** terminal (☞ page 19).

Analog RGB (15-pin) computer cable



Analog RGB (15-pin) computer cable is for connecting a PC to the TV's **PC IN** terminal (☞ page 20).

Note: Separate audio cables are required for a complete connection.

3.5mm Stereo to RCA Y-cable



3.5mm Stereo to RCA Y-Cable is for connecting audio signal from DVI device to TV.

About the connection illustrations

You can connect different types and brands of devices to your TV in several different configurations. The connection illustrations in this manual are representative of typical device connections only. The input/output terminals on your devices may differ from those illustrated herein. For details on connecting and using your specific devices, refer to each device's owner's manual.

Connecting TV to a power source

To connect AC power:

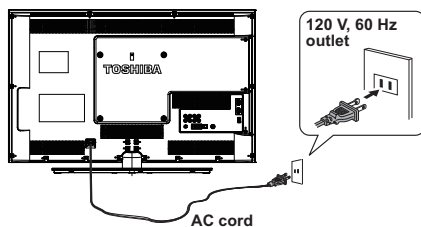

Note:

- Never connect the AC cord plug to other than the specified voltage (120 V, 60 Hz).
- If you cause a static discharge when touching the LCD TV / DVD combination and it fails to function, simply unplug the LCD TV / DVD combination from the AC outlet and plug it back in. The LCD TV / DVD combination should return to normal operation.

Connecting a VCR, and antenna, Cable TV

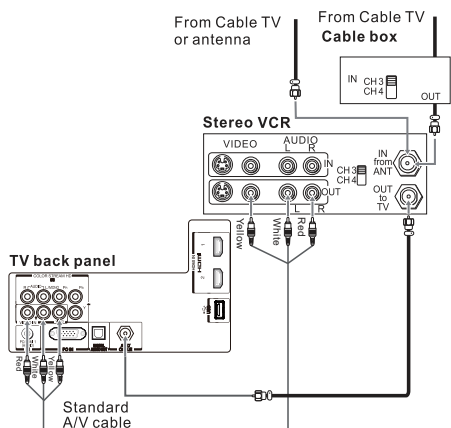

You will need:

- coaxial cables
- standard A/V cables

Note: When you use a Cable box, you may not be able to use the remote control to program or access certain features on the TV.

To view the antenna or Cable signal:

Select the **ANT/CABLE** video input source on the TV.*

To view basic and premium Cable channels:

Turn OFF the VCR. Select the **ANT/CABLE** video input source on the TV.* Tune the TV to channel 3 or 4 (whichever channel the Cable box output is set to). Use the Cable box controls to change channels.

To view the VCR:

Turn ON the VCR. Select the **VIDEO** video input source on the TV.*

* To select the video input source, press **INPUT** on the remote control (see page 30).

Connecting a camcorder

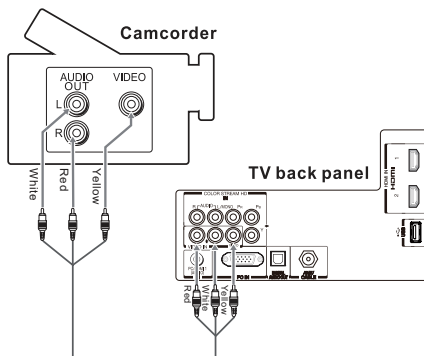

You will need:

- standard A/V cables

To view the camcorder video:

Select the **VIDEO** video input source on the TV.*

* To select the video input source, press **INPUT** on the remote control (see page 30).

The unauthorized recording, use, distribution, or revision of television programs, videotapes, DVDs, and other materials is prohibited under the Copyright Laws of the United States and other countries, and may subject you to civil and criminal liability.

Connecting a DVD player with ColorStream® (component video)

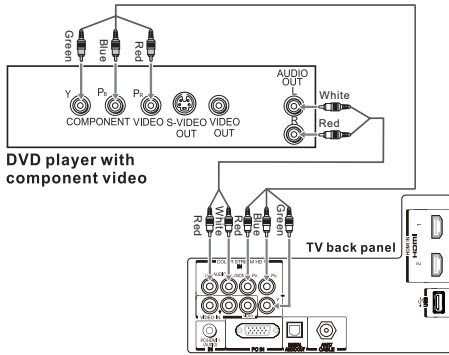

You will need:

- standard audio cables
- component video cables
 - You can connect the component video cables (plus audio cables) from the DVD player to the **COLOR STREAM HD** terminal on the TV. The **COLOR STREAM HD** terminal can be used to display Progressive (480p, 720p) and Interlaced (480i, 1080i). Please check the Owner's Manual of the DVD player in order to determine the best output signal available.
 - If your DVD player does not have component video, connect a standard A/V cable to **AUDIO/VIDEO** terminal. If your DVD player has HDMI video, see page 17.

To view the DVD player:

Turn ON the DVD player. Select the **ColorStream HD** video input source on the TV.*

* To select the video input source, press **INPUT** on the remote control (☞ page 30).

Connecting a satellite receiver

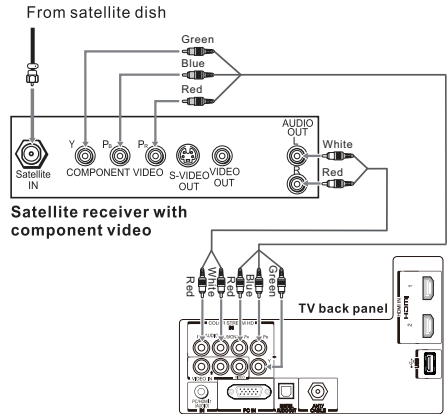

You will need:

- standard audio cables
- component video cables
 - You can connect the component video cables (plus audio cables) from the satellite receiver to the **COLOR STREAM HD** terminal on the TV. The **COLOR STREAM HD** terminal can be used to display Progressive (480p, 720p) and Interlaced (480i, 1080i). Please check the Owner's Manual of the satellite receiver in order to determine the best output signal available.
 - If your satellite receiver does not have component video, connect a standard A/V cable to **AUDIO/VIDEO** terminal.

To view satellite programs using the component video connections:

Turn on the satellite receiver. Select the **ColorStream HD** video input source on the TV.*

* To select the video input source, press **INPUT** on the remote control (☞ page 30).

The unauthorized recording, use, distribution, or revision of television programs, videotapes, DVDs, and other materials is prohibited under the Copyright Laws of the United States and other countries, and may subject you to civil and criminal liability.

Connecting an HDMI or DVI device to the HDMI® input

The HDMI input on your TV receives digital audio and uncompressed digital video from an HDMI source device, or uncompressed digital video from a DVI (Digital Visual Interface) source device. This input is designed to accept HDCP (High-Bandwidth Digital-Content Protection) program material in digital form from EIA/CEA-861-D compliant^[1] consumer electronic devices (such as a set-top box or DVD player with HDMI or DVI output). The HDMI input can accept and display VGA, SVGA, XGA, WXGA, SXGA, 480i (60 Hz), 480p (60 Hz), 720p (60 Hz), 1080i (60 Hz), and 1080p (24 Hz / 30 Hz / 60 Hz) signal formats. For detailed signal specifications, see page 75. Supported Audio format: Linear PCM, sampling rate 32/44.1/48 kHz.

Note: To connect a PC to the HDMI input, see page 20.

To connect an HDMI device, you will need:

- One HDMI cable per HDMI device
 - For proper operation, it is recommended that you use an HDMI cable with the HDMI Logo (**HDMI**®)
 - To display a 1080p/60 Hz signal format, you will need a High Speed HDMI cable. Conventional HDMI/DVI cable may not work properly.
 - HDMI cable transfers both video and audio. Separate analog audio cables are not required (see illustration).
 - See “Setting the HDMI® audio mode” (see page 28).

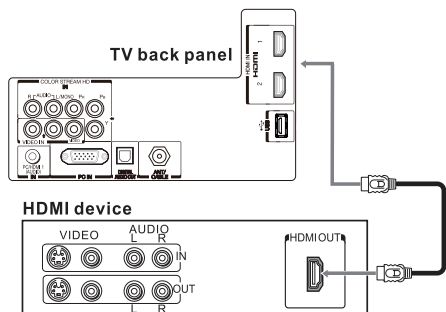

To view the HDMI device video:

Select the **HDMI 1** or **HDMI 2** video input source on the TV.*

* To select the video input source, press **INPUT** on the remote control (see page 30).

To connect a DVI device, you will need:

- One HDMI-to-DVI adapter cable
 - For proper operation, the length of an HDMI-to-DVI adapter cable should not exceed 9.8 ft (3m). The recommended length is 6.6 ft (2m).
- One 3.5mm Stereo to RCA Y-Cable
 - An HDMI-to-DVI adapter cable transfers video only. Separate analog audio cables are required (see illustration).
 - See “Setting the HDMI® audio mode” (see page 28).

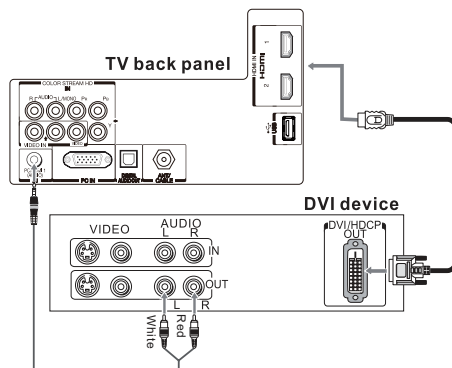

Note: To ensure that the HDMI or DVI device is reset properly, it is recommended that you follow these procedures:

- When turning on your electronic components, **turn on the TV first** and then the HDMI or DVI device.
- When turning off your electronic components, **turn off the HDMI or DVI device first** and then the TV.

[1] EIA/CEA-861-D compliance covers the transmission of uncompressed digital video with high-bandwidth digital content protection, which is being standardized for reception of high definition video signals. Because this is an evolving technology, it is possible that some devices may not operate properly with the TV.

REGZA-LINK® connection

You can control the basic functions of connected audio/video devices using the TV's remote control if you connect a REGZA-LINK® compatible audio receiver or playback device. For an explanation of setup and operations, see pages 50-51.

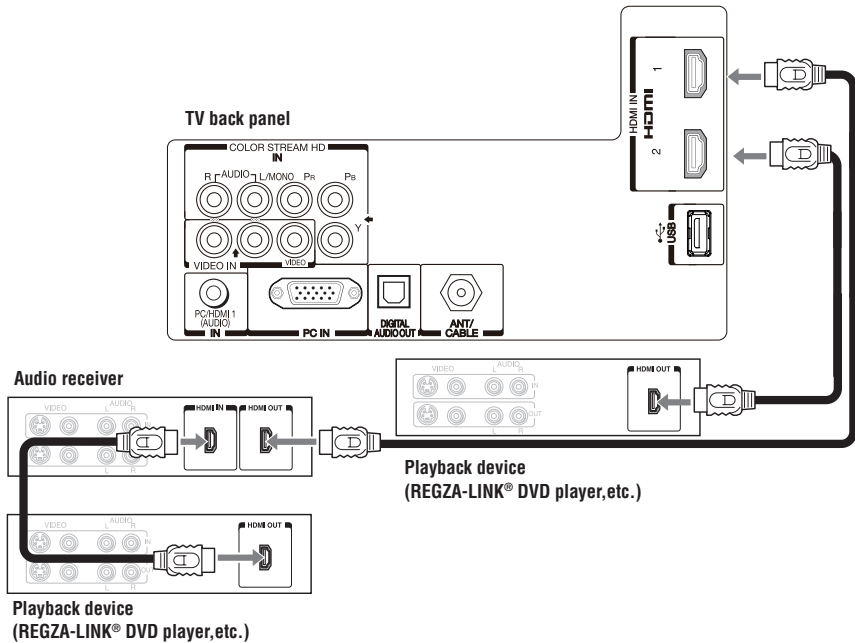

To connect an Audio Receiver and Playback Devices, you will need:

- HDMI cables (see page 14)

Note:

- If several devices are connected, REGZA-LINK® feature may not operate properly.
- For proper operation, it is recommended that you use HDMI cables with the HDMI Logo (HDMI®).

Before controlling the device(s):

- After completing the above connections, set the **REGZA-LINK Setup** menu as you desire (see page 51).
- The connected devices must also be set. For details, see the operation manual for each device.
- The REGZA-LINK® feature uses the CEC technology as regulated by the HDMI standard.
- This feature is limited to models incorporating Toshiba's REGZA-LINK®. However, Toshiba is not liable for those operations. Refer to the individual instruction manuals for compatibility information.

Note: This feature may not work properly depending on the devices that are connected.

Connecting a digital audio system



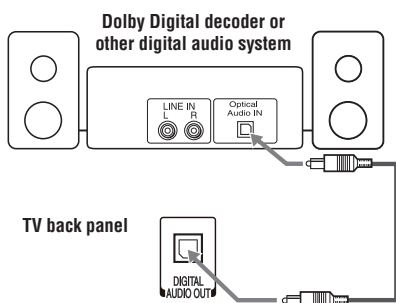

The TV's **DIGITAL AUDIO OUT** terminal outputs a Dolby® Digital  or 2-channel down-mixed PCM (Pulse-Code Modulation) signal for use with an external Dolby® Digital decoder or other external audio system with optical audio input.

You will need:

- Optical audio cable (Use an optical audio cable that has the larger “TosLink” connector and not the smaller “mini-optical” connector.)





To control the audio:

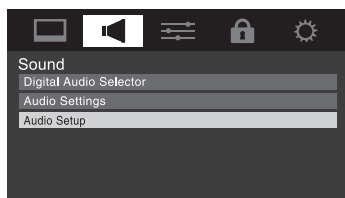

- 1 Turn on the TV and the digital audio device.
- 2 Press  on the remote control and open the **Sound** menu.
- 3 Press  or  to select **Audio Setup** and then press .

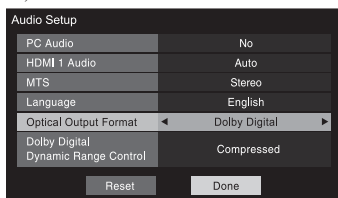

- 4 Press  or  to select **Optical Output Format**.

- 5 Press  or  to select either **Dolby Digital** or **PCM**, depending on your device.
(See “Selecting the optical audio output format” on page 40).



- 6 To save the new settings, highlight **Done** and then press .
To revert to the factory defaults, highlight **Reset** and then press .

Note:

- Some audio systems may not be compatible with Dolby Digital bitstream signals. Older audio systems that are not compatible with standard optical out signals may not work properly, creating a high noise level that may damage speakers or headphones. **THIS DAMAGE IS NOT COVERED BY YOUR WARRANTY.**
- The **DIGITAL AUDIO OUT** terminal may not output some digital audio sources because of copy restrictions.

* Manufactured under license from Dolby Laboratories. Dolby, and the double-D symbol are trademarks of Dolby Laboratories.

Connecting a personal computer (PC)

With either the PC IN or HDMI connection, you can watch your computer's display on the TV and hear the sound from the TV's speakers.

To connect a PC to the PC IN terminal on the TV:

When connecting a PC to the **PC IN** terminal on the TV, use an analog RGB (15-pin) computer cable and a PC audio cable.

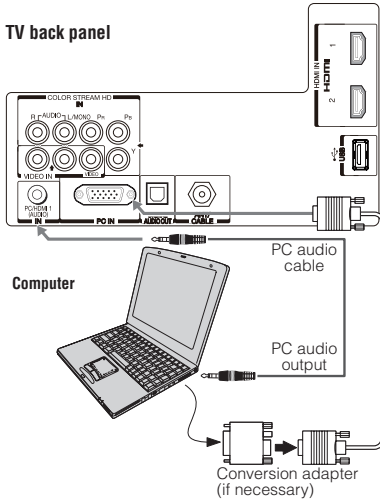

- To use a PC, set the monitor output resolution on the PC before connecting it to the TV. The PC IN terminal can accept and display VGA, SVGA, XGA, and WXGA signal formats. For detailed signal specifications, see page 75. Other formats or non-standard signals will not be displayed correctly.
- To display the optimum picture, use the PC setting feature (☞ “Using the PC settings feature” on page 45).

Note:

- The PC audio input terminals on the TV are shared with the HDMI-1 analog audio input terminals.
- Some PC models cannot be connected to this TV.
- An adapter is not needed for computers with a compatible mini D-sub 15-pin terminal.
- Depending on the DVD's title and the specifications of the PC on which you are playing the DVD-Video, some scenes may be skipped or you may not be able to pause during multi-angle scenes.

- Signal names for mini D-sub 15-pin connector

Pin No.	Signal name	Pin No.	Signal name	Pin No.	Signal name
1	R	6	Ground	11	Reserved
2	G	7	Ground	12	SDA
3	B	8	Ground	13	H-sync
4	Reserved	9	5V	14	V-sync
5	Ground	10	Ground	15	SCL

To connect a PC to the HDMI terminal on the TV:

When connecting a PC to the HDMI terminal on the TV, use an adapter cable and analog audio cables.

If connecting a PC with an HDMI terminal, use an HDMI cable. Separate analog cables are not necessary (☞ page 14).

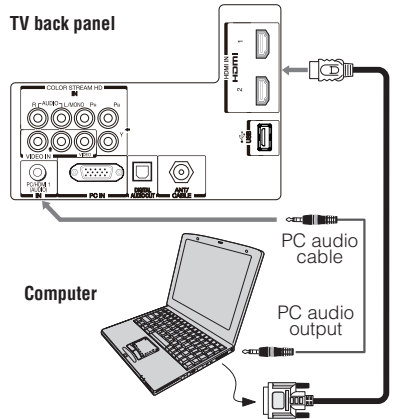

The HDMI input can accept and display VGA, SVGA, XGA, WXGA, SXGA, 480i (60Hz), 480p (60Hz), 720p (60Hz), 1080i (60Hz), and 1080p (24Hz / 60Hz) signal formats. For detailed signal specifications, see page 75.

Note:

- The edges of the images may be hidden.
- If receiving a 480i (HDMI), 480p (HDMI), 720p, 1080i, or 1080p signal program, Native mode scales the video to display the entire picture within the borders of the screen (i.e. no overscanning).

Preparing the remote control for use

The remote control can operate your LCD TV / DVD combination and control the basic functions of connected audio/video devices if you connect a REGZA-LINK® compatible audio receiver or playback device (see page 50).

Installing the remote control batteries

- 1 Open the battery lid at the bottom of remote controller.

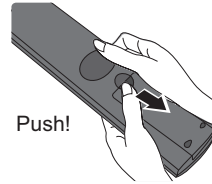

- 2 Insert the batteries, corresponding to the (+) and (-) markings on the battery compartment.

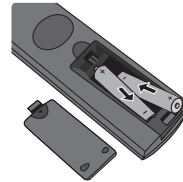

- 3 Reattach the battery cover.

Caution: Batteries must not be exposed to excessive heat such as sunshine, fire or the like.

Note:

- Be sure to use AAA size batteries.
- Dispose of batteries in a designated disposal area.
- Batteries should always be disposed of with the environment in mind. Always dispose of batteries in accordance with applicable laws and regulations.
- If the remote control does not operate correctly, or if the operating range becomes reduced, replace batteries with new ones.
- When necessary to replace batteries in the remote control, always replace both batteries with new ones. Never mix battery types or use new and used batteries in combination.
- Always remove batteries from the remote control if they are dead or if the remote control is not to be used for an extended period of time. This will prevent battery acid from leaking into the battery compartment.

Learning about the remote control

The buttons used for operating the LCD TV / DVD combination are described here. For the REGZA-LINK® remote control functions, see the section “Using REGZA-LINK®” (☞ page 50).



Note: The error message “NOT AVAILABLE” may appear if you press a key for a function that is not available.



















- 1 **POWER** turns the TV on and off. When the TV is on, the power LED indicator on the TV front will be illuminated in green.
- 2 **EJECT** ejects the disc from the disc slot.
- 3 **TV/DVD** switches to TV or DVD mode.
- 4 **FREEZE** freezes the picture. Press again to restore the moving picture (☞ page 37).
- 5 **INPUT** selects the video input source (☞ page 30).
- 6 **Channel Numbers** directly tune channels.
- 7 **FAV** accesses the Favorites List in the Channel Browser™ (☞ page 31).
- 8 **100** uses to enter two part channel numbers (☞ page 34) or to edit the Favorites List (☞ page 31).
- 9 **PIC MODE** selects the picture mode (☞ page 37).
- 10 **PIC SIZE** cycles through the picture sizes (☞ page 34).
- 11 **MUTE** reduces or turns off the sound (☞ page 39).
- 12 **SLEEP** accesses the sleep timer (☞ page 49).
- 13 **DISPLAY / INFO** displays TV status information as well as program details, when available (☞ page 52).
- 14 **CH** cycles through programmed channels when no menu is on-screen (☞ page 34).
- 15 **VOL + -** adjusts the volume level.
- 16 **DVD MENU** accesses the DVD menu (☞ page 60).
- 17 **CH RTN** returns to the last viewed channel or source (☞ page 34).
- 18 **AUDIO / MTS** selects the audio mode in ANT/CABLE source (☞ page 40); selects the DVD soundtrack language or VCD audio channel in DVD mode (☞ page 61).
- 19 **SETUP / MENU** accesses the main TV menu system (☞ page 25); configures the disc playback settings (☞ page 67).
- 20 **SUBTITLE / CC**

SUBTITLE : selects the subtitle language or switches subtitle off in DVD mode (☞ page 61).

CC : opens the closed caption selector in ANT/CABLE source (☞ page 39).
- 21 **OK** activates highlighted items in the main menu system.
- 22 **◀ / ▶** While watching TV, these buttons open the Channel Browser™ and tune to the previous/next channel in the channel history (☞ page 32). (Also see “Arrow buttons.”)

Chapter 3: Using the remote control







- 23 Arrow buttons** (▲▼◀▶) When a menu is on-screen, these buttons select or adjust programming menus. (Also see ◀ / ▶.)
- 24 CANCEL / EXIT**  closes on-screen menus.
- 25 TOP MENU**  accesses the top menu of DVDs that contain two or more titles (see page 60).
- 26 PLAY**  begins playback of the loaded disc (see page 55).
- 27 STOP**  stops playback of the loaded disc (see page 55).
- 28 PAUSE**  suspends disc playback temporarily or plays back disc frame by frame (see pages 55, 56).
- 29 FF**  fast-forwards playback of the disc (see page 56).
- 30 REV**  fast-reverses playback of the disc (see page 56).
- 31 SKIP**  skips forward to locate later DVD chapters (see page 56).
- 32 SKIP**  skips reverse to locate the beginning of current DVD chapter or locate previous chapter (see page 56).
- 33 MARKER**  bookmarks specific points in the playback range for later access (see page 58).
- 34 PLAY MODE**  sets the disc playback repeat mode (see page 59).
- 35 SLOW**  slow-forwards playback of the disc (see page 56).
- 36 SLOW**  slow-reverses playback of the disc (see page 56).
- 37 JUMP**  selects or locates a specific point with the disc playback (see page 57).
- 38 ANGLE**  changes the scene angle when playing back a DVD recorded with multiangle scenes (see page 60).
- 39 REPEAT A-B**  repeats playback of a specific section between two set points (see page 59).
- 40 RETURN**  returns to the root directory in Audio CD playback (see page 63); returns to previous directory from Media Player subfolder or sub-menu (see page 47).
- 41 ZOOM**  zooms into the center of the image during disc playback (see page 57).

Chapter 4: Menu layout and navigation



Main menu layout

The tables below and on the next page provide a quick overview of your TV's menu system. To open the main menus (illustrated below), press **SETUP**  on the remote control or MENU on the TV control panel.

Icon	Item	Option
	Mode	→ Sports / Standard / Movie / PC / Preference
	Picture Settings	→ [Opens the Picture Settings menu]
	Noise Reduction	→ [Opens the Noise Reduction menu]
	Game Mode	→ Off / On
	Theater Settings	→ [Opens the Theater Settings menu]
	Digital Audio Selector	→ [Launches the temporary Audio Selector]
	Audio Settings	→ [Opens the Audio Settings menu]
	Audio Setup	→ [Opens the Audio Setup menu]
	CC Selector	→ [Launches the temporary CC Selector]
	Base CC Mode	→ Off / CC1 / CC2 / CC3 / CC4 / T1 / T2 / T3 / T4
	Digital CC Settings	→ [Opens the Digital CC Settings menu]
	Input Labeling	→ [Opens the Input Labeling menu]
	Menu Language	→ English / Français / Español
	Channel Browser Setup	→ [Opens the Channel Browser Setup menu]
	REGZA-LINK Player Control	→ [Opens the REGZA-LINK Player Control menu]
	Energy Saving Settings	→ [Opens the Energy Saving Settings menu]
	Enable Rating Blocking	→ Off / On
	Edit Rating Limits	→ [Opens the Edit Rating Limits menu]
	Input Lock	→ Off / Video / Video+
	Panel Lock	→ Off / On
	GameTimer	→ Off / 30 min / 60 min / 90 min / 120 min
	New PIN Code	→ [Opens the New PIN Code entry screen]
	Installation	→ [Opens the Installation menu (see page 26)]
	REGZA-LINK Setup	→ [Opens the REGZA-LINK Setup menu]
	Sleep Timer	→ [10-minute increments, from 0 min to a maximum of 12 hours]
	PC Settings	→ [Opens the PC Settings menu]
	Media Player	→ [Opens the Media Player menu]

Setup / Installation menu layout

The **Installation** menu contains the **Terrestrial** and **System Status** menus.

To open the **Installation** menu (illustrated below), press  on the remote control or MENU on the TV control panel, open the **Setup** menu, select **Installation**, and press .

Icon	Item	Option
	Input Configuration	→ [Opens the Input Configuration menu]
	Channel Program	→ [Start Scan] → [Scans for new channels on ANT/CABLE]
	Channel Options	→ [Opens the Skip / Lock Channel menu]
	Channel Tuning Mode	→ Standard / Auto / Digital
	Time Zone	→ Eastern / Newfoundland / Atlantic / Hawaii / Alaska / Pacific / Mountain / Central
	Signal Meter	→ [Opens the Signal Meter menu]

System Status









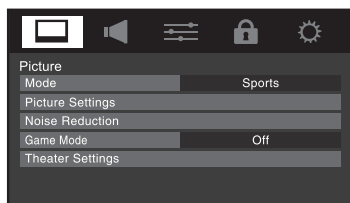

	System Information	→ [Opens the System Information screen]
--	--------------------	---

Navigating the menu system

You can use the buttons on the remote control or TV control panel to access and navigate your TV's on-screen menu system.

- Press  to open the menu system.



- When a menu is opened, use the up/down/left/right arrow buttons (, , , ) on the remote control or , , ,  on the TV control panel to move in the corresponding direction in the menu.
- Press  to save your menu settings or select a highlighted item. (A highlighted menu item appears in a different color in the menu.)
- All menus close automatically if you do not make a selection within 60 seconds, except the signal meter menu, which closes automatically after about 5 minutes.
- To close a menu instantly, press .

Note:

The menu background may sometimes appear black, depending on the signal the TV is receiving. This is not a sign of malfunction.

Initial Setup

When you first turn on or reset the TV, the Initial Setup window will appear.

- 1 In the **Menu Language** field, press ◀ or ▶ to select your preferred language.
- 2 Press ▲ or ▼ to select **Time Zone Setup** and set your desired time zone with ◀ or ▶ and press **OK**.
- 3 Next, the **Location** setting window will appear. For normal home use, press ◀ or ▶ to select **Home** and press **OK**.
- 4 Next, **ANT/CABLE In** setup window will appear. Press ◀ or ▶ to select the input source (**Cable** or **Antenna**) for the **ANT/CABLE** input on the TV and press **OK**.
- 5 If you select **Antenna**, the **Channel Tuning Mode** setup window will appear. To tune only digital channels, select **Digital**. To tune digital channels preferentially over analog when entering channel number directly, select **Auto**. For normal tuning, select **Standard**. Press **OK** to continue to Auto Tuning.
- 6 Press **OK** to select **Start Scan** and continue with the Auto Tuning.

You can stop the Initial Setup with **CANCEL** (⏻). However if you do not finish the entire Initial Setup process by pressing **POWER** (⏻) until step 5 above, the Initial Setup window will appear every time you turn on the TV.

Selecting the menu language

You can choose from three different languages (English, French and Spanish) for the on-screen display of menus and messages.

To select the menu language:

- 1 Press **SETUP** (⏻) and open the **Preferences** menu, highlight **Menu Language**.
- 2 Press ◀ or ▶ to select your preferred menu language.

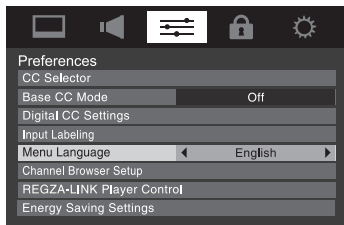

- 3 Press **CANCEL** (⏻) to close the **Preferences** menu.

Configuring the antenna input source for the ANT/CABLE terminal

To configure the ANT/CABLE input source:

- 1 Press **SETUP** (⏻) and open the **Setup** menu.
- 2 Highlight **Installation** and press **OK**.

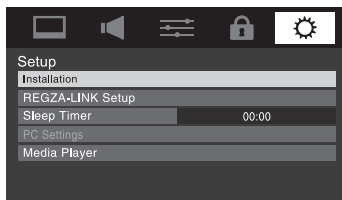

- 3 A new set of **Installation** menu icons will appear, as shown below. Open the **Terrestrial** menu, highlight **Input Configuration**, and press **OK**.

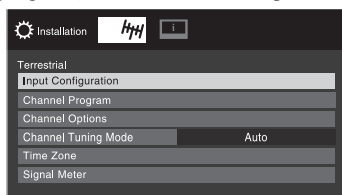

- 4 Highlight **ANT/CABLE In** and press ◀ or ▶ to select the input source (**Cable** or **Antenna**) for the **ANT/CABLE** input on the TV.

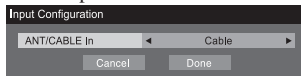

- 5 To save your new settings, highlight **Done** and press **OK** (⏻). To revert to your original settings, highlight **Cancel** and press **OK** (⏻).

Programming channels into the TV's channel memory

When you press **CH** (⏻) or **CH** (⏻) on the remote control or TV control panel, your TV will stop only on the channels you programmed into the TV's channel memory.

Follow the steps below to program channels into the TV's channel memory.

Programming channels automatically

Your TV can automatically detect all active channels in your area and store them in its memory. After the channels are programmed automatically, you can manually add or erase individual channels in the channel memory.

(continued)

Note:

- You must configure the ANT/CABLE input source before programming channels (see page 26).
- The automatic channel programming process will erase channels that were previously programmed into the TV's memory.
- To tune the TV to a channel not programmed in the channel memory, you must use the Channel Number buttons on the remote control.
- Programming channels when the ANT/CABLE input is configured for **Cable** will take substantially longer than when the antenna input is configured for **Antenna**. This is normal; however, once channel programming is finished, you should not have to repeat the programming process again unless your Cable TV service lineup changes significantly.

To program channels automatically:

- 1 Configure the antenna input source, if you have not already done so (see page 26).
- 2 Press **SETUP** and open the **Setup** menu.
- 3 Highlight **Installation** and press **OK**.

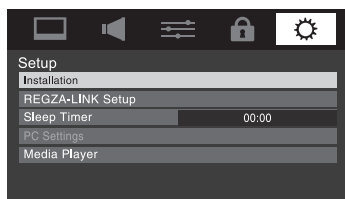

- 4 A new set of **Installation** menu icons will appear, as shown below. Open the **Terrestrial** menu, highlight **Channel Program** to bring up the **Start Scan**, and press **OK** again to begin channel programming.

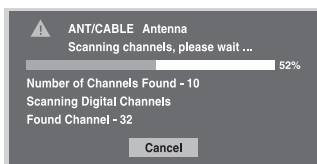
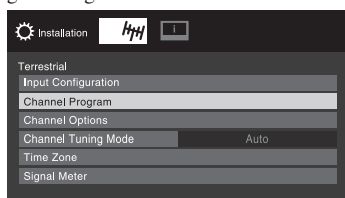

The TV will automatically cycle through all the antenna channels, and store all active channels in the channel memory. While the TV is cycling through the channels, the message “Scanning channels, please wait” will appear.

- 5 To cancel channel programming, press **CANCEL** on the remote control (or highlight **Cancel** in the on-screen display and press **OK**).

When channel programming is finished, press **CH** or **CH** to view the programmed channels.

Setting channel skip

To prevent certain channels from being viewed, channel positions can be skipped.

- 1 From the **Setup** menu, highlight **Installation** and press **OK**.
- 2 Press **▲** or **▼** to select **Channel Options** and press **OK**. The list of channels will appear.



- 3 Press **▲** or **▼** to select a channel position to be skipped and press **OK**. A tick will appear in the box. To remove the tick, press **OK** again.

To add a channel to the channel memory:

Highlight the checked box next to the channel number you want to add, and then press **OK** to remove the tick.

To block channels in the channel memory:

You can block specific channels. You will not be able to tune blocked channels unless you unlock them.

- 1 From the **Channel Options** menu, press **▶** to move to the channel lock list.

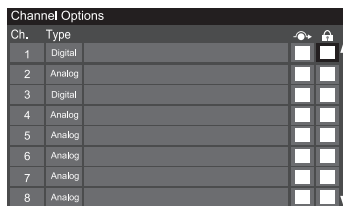

- 2 Press **▲** or **▼** to select a channel position to be locked and then press **OK**. Enter your four-digit PIN code. A tick will appear in the box. To remove the tick, press **OK** again.

Note: If the PIN code has not been set yet, a warning message will appear.

- 3 To save the setting, press **CANCEL**.

(continued)

To manually add digital subchannels on a physical channel:

Use the Channel Numbers and the Dash (**100**) on the remote control to enter the channel number (for example, 56-1).

If the channel is found, the number will be added to the list and the box will be unchecked.

If the channel is not found, a message will appear.

Note: *Skipped channels cannot be selected with **CH** or **CH**; however, they can still be accessed using the number keys on the remote control.*

To remove encrypted channels from the channel memory:

If an encrypted channel is accidentally added to the channel list by programming channels, you can remove the unwanted encrypted (non-viewable) channel while you are channel surfing. When you tunes to an encrypted channel, the following message will appear.

Digital Channel Is Encrypted - Press 1 on remote to remove channel

Press **1** while the message is on the screen to remove the unnecessary channel from the channel list.

Setting the HDMI® audio mode

To set the HDMI® audio mode:

- 1** Press **SETUP** and open the **Sound** menu.
- 2** Highlight **Audio Setup** and press **OK**.
- 3** Press **▲** or **▼** to select **HDMI 1 Audio** and then press **◀** or **▶** to select the HDMI 1 audio mode (**Auto**, **Digital**, or **Analog**). (**Auto** is the recommended mode.) See “Connecting an HDMI or DVI device to the HDMI® input” (page 17).

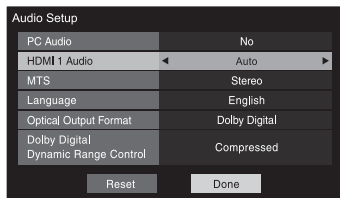

Mode	Description
Auto	When viewing the HDMI 1 input, if digital audio from the HDMI input is available, it will be output. If not, the TV will automatically detect and output analog audio from the PC Audio input.
Digital	When viewing the HDMI 1 input, digital audio from the HDMI input will be output.
Analog	When viewing the HDMI 1 input, analog audio from the PC Audio input will be output.

- 4** To save your settings, highlight **Done** and press **OK**.

Note: *Because the PC and HDMI1 inputs share the same set of analog audio inputs, the **PC Audio** menu setting influences the **HDMI 1 Audio** menu setting. If **PC Audio** is set to “**No**” the **HDMI 1 Audio** setting changes to “**Auto**”. If **PC Audio** is set to “**Yes**” the **HDMI 1 Audio** setting is set to “**Digital**” and is grayed out in the menu. (Also see item 3 on page 13 and “Setting the PC Audio” on page 45.)*

Viewing the digital signal meter

You can view the digital signal meter in the ANT/CABLE digital TV input source only.

To view the digital signal meter:

- 1 Press **SETUP** and open the **Setup** menu.
- 2 Highlight **Installation** and press **OK**.
- 3 A new set of Installation menu icons will appear. Open the **Terrestrial** menu, highlight **Signal Meter**, and press **OK**.
- 4 Press **▲▼◀▶** to select the antenna input and digital channel whose signal you want to check.
- 5 If you want to know the detail information of the presentation channel, Highlight **Advanced** and press **OK**.

Note:

- The physical digital channel number listed in the Signal Meter screen may not correspond to a virtual TV channel number. Contact your local broadcasters to obtain the RF channel numbers for your local digital stations.
- The signal strength does not change between virtual channels on the same physical channel.

To close the screen and return to the Installation menu:

Highlight **Done** and press **OK**.

To return to normal viewing:

Press **CANCEL**.

Setting the time zone

The Time Zone setup will allow you to specify the correct time zone for your region. This feature will allow the TV status information to show the correct time zone information for your viewing area (see page 52).

To set the time zone:

- 1 From the **Setup** menu, highlight **Installation** and press **OK**. A new set of Installation menu icons will appear.
- 2 Highlight **Time Zone**, and press **OK**.
- 3 Press **◀** or **▶** to select the region, highlight **Done**, and then press **OK**.

After the time zone has been set, you will be asked to set the current Daylight Saving Time status.

To set the Daylight Saving Time status:

- 1 Press **◀** or **▶** to select **Yes** or **No**, highlight **Done**, and then press **OK**.

Viewing the system status

To view the system status:

- 1 Press **SETUP** and open the **Setup** menu.
- 2 Highlight **Installation** and press **OK**.
- 3 A new set of Installation menu icons will appear. Open the **System Status** menu, highlight **System Information**, and press **OK**.
- 4 Press **◀▶** to scroll through the menu bar to select the **Factory Defaults** or **Support Information** and view the related information.

To close the screen and return to the Installation menu:

Highlight **Done** of Support Information or highlight **No** of Factory Defaults, and press **OK**.

To return to normal viewing:

Press **CANCEL**.

Reset Factory Defaults

To reset all settings and channels to their factory default values:

- 1 Press **SETUP** and open the **Setup** menu.
- 2 Highlight **Installation** and press **OK**. A new set of Installation menu icons will appear.
- 3 Open the **System Status** menu, highlight **System Information**, and press **OK**.
- 4 Press **◀▶** to scroll through the menu bar to select **Factory Defaults**.
- 5 Highlight **Yes** and press **OK**.
- 6 (If PIN code has been set, enter your PIN code. Press **◀** or **▶** to select **Done** and press **OK**.) A warning message will appear, select **Yes** and press **OK**, the TV will turn off automatically after a few seconds. After the TV turns off, unplug the TV power cord and then plug it in again to complete the reset process.

To cancel the reset:

Select **No** and press **OK** in step 5 above.

Selecting the video input source to view

To select the video input source to view:

- 1 Press **INPUT** on the remote control or TV control panel.
 - 2 And then either:
 - a) Press 0–6 ; or
 - b) Repeatedly press **▲▼** on the remote control and then press **OK** to change the input; or
 - c) Repeatedly press **INPUT** on the remote control or TV control panel to change the input.
- The current signal source displays in the top right corner of the **Input Selection** screen.

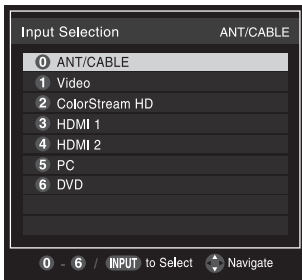

Note:

- You can label the video input sources according to the specific devices you have connected to the TV (see “Labeling the video input sources” at right).
- Sources can be “hidden” (see “Labeling the video input sources” at right).
- “No video signal” will appear randomly on the screen if no signal is received in video input mode.
- If CEC device is connected to an HDMI input, the REGZA-LINK® icon will appear.

If a REGZA-LINK® device with HDMI switching capability (e.g. Audio Receiver) is connected to the HDMI input:

Press **INPUT** on the remote or TV control panel repeatedly to highlight **HDMI 1** or **HDMI 2**.

If the connected CEC device has any connected devices, a separate device selection popup window will appear.

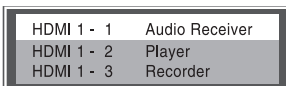

Press **INPUT** repeatedly to highlight the desired input source, and then press **CANCEL**.

Note:

- When selecting REGZA-LINK® input sources from the popup window using **INPUT**, some REGZA-LINK® devices may automatically turn on.
- When selecting input sources using **▲▼**, you will have to press **OK** to actually select a particular device from the popup window.

Labeling the video input sources

You can label each video input source according to the type of device you connected to each source, from the following preset list of labels:

- -- (default label)
- Audio Receiver
- Cable
- Compact Disc
- DTV
- DVD
- Game Console
- HDMI Switch (HDMI inputs only)
- Laser Disc
- Satellite/DSS
- VCR
- Video Recorder
- Hide (to hide an unused input in the **Input Selection** screen and in the Channel Browser™ Inputs list)

Note: If you select PC in the Input Selection screen, you can choose only “--”, “Game Console”, or “Hide” as the label.

To label the video input sources:

- 1 Press **SETUP** and open the **Preferences** menu.
- 2 Highlight **Input Labeling** and press **OK**.

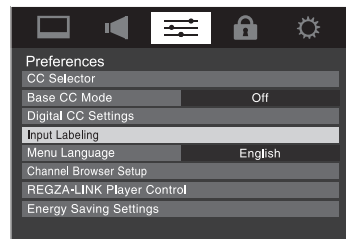

(continued)

- Press **▲** or **▼** to highlight the video source you want to label.

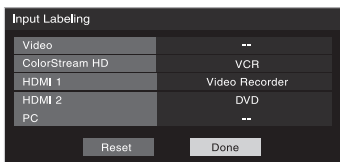

- Press **◀** or **▶** to select the desired label for that input source. If a particular input is not used, you can select **Hide** as the label, which will cause that input to be “grayed out” in the Input Selection screen and skipped over when you press **INPUT** on the remote control.
- To save the new input labels, highlight **Done** and press **OK**.

Input labeling example:

The screen below left shows the default **Input Selection** screen (with none of the inputs labeled as a specific device). The screen below right is an example of how you could label the inputs if you connected a VCR to ColorStream HD, a video recorder to HDMI 1, and a DVD player to HDMI 2.

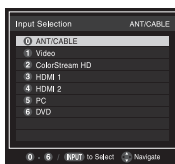

Input Selection screen with no inputs labeled.

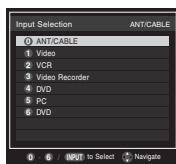

Input Selection screen with all inputs labeled.

To clear the input labels:

- Press **SETUP** and open the **Preferences** menu.
- Highlight **Input Labeling** and press **OK**.
- Highlight **Reset** and press **OK**.

Tuning channels

Tuning channels using the Channel Browser™

The Channel Browser™ provides an easy navigation interface for all your channels and inputs. This feature allows you to:

- Navigate the contents of all of your inputs.
- Keep a list of your favorite channels (see “Favorites Browser;” below).
- Quickly surf and tune your recently viewed channels/inputs from the Channel Browser™ History List (illustrated on the next page).
- Surf via Browse mode (to immediately tune channels as you highlight them in the Channel Browser™) or Select mode (to surf over channels in the Channel Browser™ before you select one to tune).
- Quickly change inputs from the Inputs List.
- Quickly select REGZA-LINK® devices from the REGZA-LINK® List.

Favorites Browser

The Favorites Browser allows you to quickly set up a favorite channels/inputs list that is integrated into the Channel Browser™.

To add a favorite channel/input:

- Tune to the channel or input.
- Press and hold **FAV** for 3 seconds.

Note: The channel or input is added to the beginning of the Favorites list on the left side of the Channel Browser™.

To delete a favorite channel/input:

- Press **FAV** to open the Favorites browser list.
- Highlight the channel or input to delete by pressing **BACK** or **NEXT** (**◀** or **▶**).
- Press and hold **100** for 3 seconds. The channel/input will be removed from the Favorites list.

To set up the Channel Browser™:

- From the **Preferences** menu, highlight **Channel Browser Setup** and press **OK**.
- Press **▲** to highlight **Navigation**, and then press **◀** or **▶** to select either **Browse Mode** or **Select Mode**.

(continued)

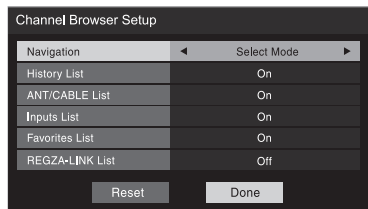

- 3 Press ▼ to highlight **History List**, and then press ◀ or ▶ to select the setting you prefer: either **On**, or **Off**.

Note: **History List** will be cleared every time the TV is powered off.

- 4 Press ▼ to highlight **ANT/CABLE List**, and then press ◀ or ▶ to select **On** or **Off**.
- 5 Press ▼ to highlight **Inputs List**, and then press ◀ or ▶ to select **On** or **Off**.
- 6 Press ▼ to highlight **Favorites List**, then press ◀ or ▶ to select **On** or **Off**.
- 7 Press ▼ to highlight **REGZA-LINK List**, and then press ◀ or ▶ to select **On** or **Off**.

Note: REGZA-LINK List will be automatically grayed out and set to **Off** when **Enable REGZA-LINK** is switched to **Off**. (See "To set the REGZA-LINK® Setup" on page 51 for more information.)

- 8 To save your entries, highlight **Done** and press (OK). To return to factory defaults, highlight **Reset** and press (OK).

To open the Channel Browser™:

- Press **BACK** (CB) ◀ or **NEXT** (CA) ▶ on the remote control.
- Press ◀ to surf backward through the previously tuned channels in the History list, the channels in the ANT/ CABLE channel list, the inputs in the Inputs list, the favorite channels/inputs in the Favorites list, or the REGZA-LINK® devices in the REGZA-LINK® list.
- Press ▶ to surf forward through the channel History, the ANT/CABLE channel list, the Inputs list, the favorite channels/inputs in the Favorites list, or the REGZA-LINK® list.

Elements of the Channel Browser™

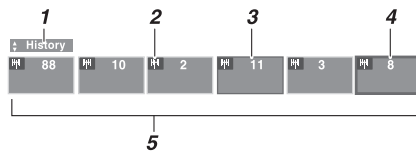

- 1 Current list (**History**, **ANT/CABLE**, **Inputs**, **Favorites**, or **REGZA-LINK**)
- 2 Input type
- 3 Channel or input currently being viewed
- 4 Channel or input that is currently highlighted in the browser
- 5 Channels stored in the History List

To toggle among the available lists:

After opening the Channel Browser™, press ▲ or ▼ to toggle among **History**, **ANT/CABLE**, **Inputs**, **Favorites**, and **REGZA-LINK**.

Note:







- The Channel Browser™ opens in **History List** by default. Once another list has been selected, the Channel Browser™ will open in the last selected list.
- If all lists are turned off, pressing **BACK** (CB) ◀, or **NEXT** (CA) ▶, or **(FAV)** will not display the Channel Browser™. If **Favorites List** is turned off, **(FAV)** will have no effect.
- Pressing **(FAV)** will bring up the Channel Browser™ Favorites list regardless of the last selected list in the Channel Browser™.

To tune to a channel or input in Browse mode:

- 1 While watching TV, press **BACK** (CB) ◀ or **NEXT** (CA) ▶ to open the Channel Browser™ and surf back to a previous item or surf forward to the next item in the list. In **Browse mode**, when you stop on an item in the Channel Browser™, it will be highlighted and the TV will automatically tune to the channel or input.
- 2 Press **CANCEL** (CM) to close the Channel Browser™.



(continued)

To tune to a channel or input in Select mode:





- 1 While watching TV, press   or   to open the Channel Browser™ and surf back to a previous item or forward to the next item in the list.
In **Select** mode, when you stop on an item in the Channel Browser™, it will be highlighted but you must press  to tune the TV to the highlighted item.
- 2 Press  to tune the TV to the highlighted item.
- 3 Press  to close the Channel Browser™.

Adding and clearing channels and inputs in the History List

Adding channels and inputs to the History List:

As a channel or input is tuned, the Channel Browser™ adds it to the History List and displays it on the “right side” of the Channel Browser™. Previously tuned channels/inputs are “shifted” to the left, eventually moving off the left side. Press   to surf backward through the previously tuned channels/inputs. Any channel or input that is tuned repeatedly will not be repeated in the History List, but instead is moved to the end of the list on the right side of the Channel Browser™.

The Channel Browser™ will store the following channels:

- All channels that are tuned using the numeric buttons on the remote control.
- All channels that are tuned using   or   on the remote control.

Note: Whenever an item is selected that cannot be tuned (for various reasons), the TV will automatically tune to the previously viewed channel or input.

Clearing channels from the History List:

- Reconfiguring the **ANT/CABLE** input will clear the History List.

Note: See page 26 for details on configuring the antenna input.





- Turning off the TV will clear the History List.

Setting the Channel Tuning Mode

This feature allows you to choose how tuning will be handled for analog and digital channels when the TV is in Antenna mode.



Note: To use this feature, the **Input Configuration** must be set to **Antenna** (see page 26).

The channel tuning mode has three options.

Mode	Description
Standard	Both analog and digital channels can be tuned normally
Auto (default)	Digital channels will have priority when manually entering a channel number using the Channel Number (0-9) on the remote control, analog channels can still be tuned by   /   , if available
Digital	Only digital channels can be tuned

Note: Digital mode will be most useful after analog channels were shut down by the government in 2009.

To set the Channel Tuning Mode:

- 1 From the **Setup** menu, highlight **Installation** and press . A new set of **Installation** menu icons will appear.
- 2 Open the **Terrestrial** menu, highlight **Channel Tuning Mode**, and then press  or  to select your desired mode.

Note:

- The Channel Options windows as well as the Channel Browser ANT/CABLE list will be updated automatically when you change the mode. Also, the History List will be cleared, but the Favorites List will be saved.
- Even if the Channel Tuning Mode is set to **Digital**, analog channel 3 will still be the default channel to prevent the initial case where no digital channels have been found in prior channel scans. (Channel Options will not have anything listed until a scan is done.)

(continued)

Tuning to the next programmed channel

To tune to the next programmed channel:

Press or on the remote control or TV control panel.

Note: This feature will not work unless you program channels into the TV's channel memory (see page 26).

Tuning to a specific channel (programmed or unprogrammed)

Tuning analog channels:

Press the Channel Number (0–9) on the remote control. For example, to select channel 125, press 1, 2, 5, then .

Tuning digital channels:

Press the Channel Number (0–9) on the remote control, followed by the dash () button and then the sub-channel number. For example, to select digital channel 125-1, press 1, 2, 5, -, 1, then .

Note: If a digital channel is not programmed—either through the automatic channel scan (see page 26) or the Channel add function (see page 27)—you will have to tune the RF channel using the Channel Number and dash () on the remote control.

Switching between two channels using Channel Return

The Channel Return feature allows you to switch between two channels without entering an actual channel number each time.

- 1 Select the first channel you want to view.
- 2 Select a second channel using the Channel Number buttons (and the dash () button if selecting a digital channel).
- 3 Press on the remote control. The previous channel will display. Each time you press , the TV will switch back and forth between the last two channels that were tuned.

Note: If you press from a non-antenna input, the TV will return to the last-viewed input.

Switching between two channels using SurfLock™

The SurfLock™ feature temporarily “memorizes” one channel to the button, so you can return to that channel quickly from any other channel by pressing .

To memorize a channel to the button:

- 1 Tune the TV to the channel you want to program into the button.
- 2 Press and hold for about 2 seconds until the message “Memorized” appears on-screen. The channel has been programmed to the .
- 3 You can then change channels repeatedly, and when you press , the memorized channel will be tuned.

The TV will return to the memorized channel one time only. Once you press and then change channels again, the CH RTN memory will be cleared and the button will function as Channel Return, by switching back and forth between the last two channels that are tuned. This feature also works for external inputs.

Selecting the picture size

You can view many program formats in a variety of picture sizes — **Full**, **TheaterWide 1**, **TheaterWide 2**, **TheaterWide 3**, **Native**, **4:3**, **Normal**, and **Dot by Dot**.

Note: The “picture size” illustrations are examples only. The format of the image (in any of the picture sizes) will vary depending on the format of the signal you are currently watching. Select the picture size that displays the current program the way that looks best to you.

You can save separate picture size preferences for each input on your TV.

To select the picture size using the remote control:

- 1 Press on the remote control.
- 2 While the **Picture Size** menu is opened, you can do one of the following to select the desired picture size:
 - Repeatedly press .
 - Press the corresponding Number button (0–5) while the **Picture Size** menu is opened.
 - Press or while the **Picture Size** menu is opened.

(continued)

To select the picture size using the menus:

- 1 Select **Picture Size** in the **Theater Settings** menu.
- 2 Press ◀ or ▶ to select the desired picture size setting.
- 3 Highlight **Done** and press **OK**.

Note: Some of the picture sizes may not be available depending on the receiving signal format (those will be "grayed out" in the **Picture Size** screen).

Using these functions to change the picture size (i.e., changing the height/ width ratio) for any purpose other than your private viewing may be prohibited under the Copyright Laws of the United States and other countries, and may subject you to civil and criminal liability.

Note: If you select one of the TheaterWide® picture sizes, the top and bottom edges of the picture (including subtitles or captions) may be hidden. To view the hidden edges, either scroll the picture (**TheaterWide 2** and **3** only) or try viewing the program in **Full** or **4:3** picture size.

Picture Size

Full

(for 16:9 [480i, 480p] source programs only)

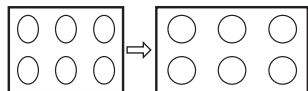

If receiving a squeezed 4:3 format program, the picture is stretched wider to fill the width of the screen but not stretched taller.

(for 1080i, 1080p, and 720p program sources)

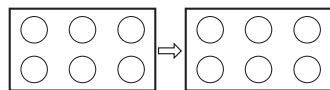

The edges surrounding the picture may be hidden.

TheaterWide 1

(for 4:3 format programs)

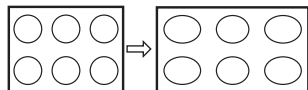

The center of the picture remains close to its original proportion, but the left and right edges are stretched wider to fill the screen.

Picture Size

TheaterWide 2

(for letter box programs)

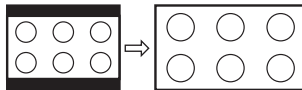

The top and bottom edges of the picture may be hidden*.

TheaterWide 3

(for letter box programs with subtitles)

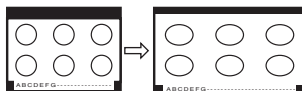

The top and bottom edges are hidden*.

Native

(for 480i (HDMI), 480p (HDMI), 720p, 1080i, and 1080p signal programs)

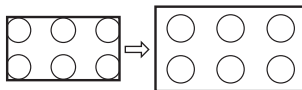

- If receiving a 480i (HDMI), 480p (HDMI), 720p, 1080i, or 1080p signal program, Native mode scales the video to display the entire picture within the borders of the screen (i.e. no overscanning).
- This is especially useful for external HD sources such as DVHS movies, or PC graphics.

Note:

- This mode is supported only for HDMI (1080p, 1080i, 720p, 480p, and 480i), ColorStream (1080i and 720p), and ANT/ CABLE (digital) inputs (1080p, 1080i, and 720p).
- Depending on the input signals, the border of the picture may be hidden, displayed in black, or noisy.

(continued)

Picture Size

4:3

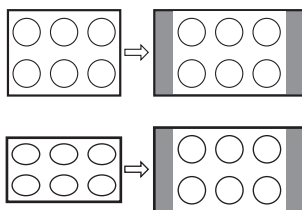

Some program formats will display with sidebars and/or bars at the top and bottom.

Normal

(for VGA, SVGA, XGA, WXGA, and SXGA sources and Photo files)

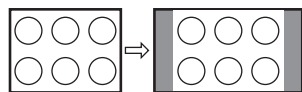

“Normal” is a non-stretched display. Some input signal formats will display with sidebars and/or bars at the top and bottom.

Dot by Dot

(for VGA, SVGA, XGA, WXGA, and SXGA sources only)

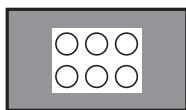

The “Dot by Dot” picture is non-scaling display. Depending on the input signal formats, picture is displayed with sidebars and/or bars at the top and bottom. (Example: VGA input source)

* To view the hidden areas (such as subtitles or captions), see below “Scrolling the TheaterWide® picture”.

Scrolling the TheaterWide® picture (TheaterWide 2 and 3 only)

You can set separate scroll settings for the TheaterWide 2 and TheaterWide 3 modes for each input.

To set the scroll settings:

- 1 Press **SETUP** and open the **Picture** menu.
- 2 Highlight **Theater Settings** and press **OK**.

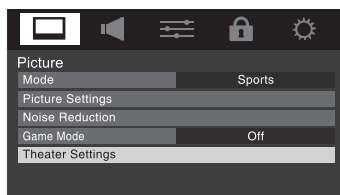

- 3 In the **Picture Size** field, select either **TheaterWide 2** or **TheaterWide 3** (you cannot scroll in any other mode).
- 4 Press **▼** to highlight the **Picture Scroll** field.
- 5 Press **◀** or **▶** to scroll the picture up and down as needed.
- 6 To save the new settings, highlight **Done** and press **OK**. To revert to the factory defaults, highlight **Reset** and press **OK**.

Note: When receiving a signal at 480i resolution, the picture scroll function may have limited adjustment range.

Using the auto aspect ratio feature

When the auto aspect ratio feature is set to **On**, the TV will automatically select the picture size when one of the following input sources is received:

- A 480i, 480p, 720p or 1080i digital signal from the **ANT/CABLE** input
- A 480i signal from the **VIDEO**, **ColorStream HD** or **DVD** input
- A 480i, 480p, 720p, 1080i, 1080p or VGA (60Hz) signal from the **HDMI 1/2** input

Aspect ratio of signal source	Automatic aspect size (automatically selected when Auto Aspect is On)
4:3 normal	4:3
4:3 letter box	TheaterWide 2
16:9 full	Full
Not defined (no ID-1 data or HDMI aspect data)	The current picture size you set under “Selecting the picture size” on page 34.

Note: The auto aspect ratio feature is not applicable to PC input.

(continued)

To turn on the auto aspect ratio feature:

- 1 Press **SETUP** and open the **Picture** menu.
- 2 Highlight **Theater Settings** and press **OK**.
- 3 In the **Auto Aspect Ratio** field, select **On**.
- 4 To save the new settings, highlight **Done** and press **OK**. To revert to the factory defaults, highlight **Reset** and press **OK**.

To turn off the auto aspect ratio feature:

Select **Off** in step 3 above.

Selecting the cinema mode

When you view a DVD (3:2 pulldown processed) from a DVD player connected to the **VIDEO**, **ColorStream HD** (component video), or **HDMI** inputs on the TV, smoother motion can be obtained by setting the **Cinema Mode** to **Film**.

To set the Cinema Mode to Film:

(available for 480i and 1080i signals)

- 1 Press **SETUP** and open the **Picture** menu.
- 2 Highlight **Picture Settings** and press **OK**.
- 3 Highlight **Advanced Picture Settings** and press **OK**.
- 4 In the **Cinema Mode** field, select **Film**.
- 5 To save the new settings, highlight **Done** and press **OK**. To revert to the factory defaults, highlight **Reset** and press **OK**.

To set the Cinema Mode to Video:

Select **Video** in step 4 above.

Using the FREEZE feature

To use the FREEZE feature:

- 1 When viewing the TV, press **FREEZE** to make the picture a still picture.
- 2 To return to the moving picture, press **FREEZE** again (or any other button).

Note: If the TV is left in **FREEZE** mode for more than 15 minutes, the **FREEZE** mode will automatically be released and the TV will return to moving picture.

Using the **FREEZE** function for any purpose other than your private viewing may be prohibited under the Copyright Laws of the United States and other countries, and may subject you to civil and criminal liability.

Adjusting the picture

Selecting the picture mode

You can select your desired picture settings from four different modes, as described below.

Mode	Picture Quality
Sports	Bright and dynamic picture (factory setting)
Standard	Standard picture settings (factory setting)
Movie	Lower contrast for darkened room (factory setting)
PC	Designed for viewing of PC tables and documents
Preference	Your personal preferences

Note: *PC mode is available for HDMI and PC inputs only (grayed out for other input sources).*

To select the picture mode using the menu system:

- 1 Press **SETUP** and open the **Picture** menu.
- 2 Highlight **Mode** and press **OK**.

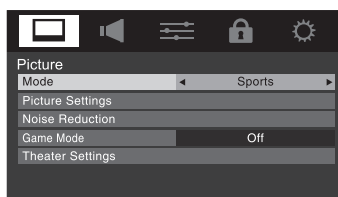

- 3 Press **▲** or **▼** to select the picture mode you prefer and press **OK**.

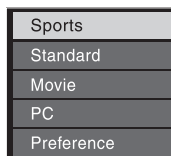

(continued)

Adjusting the picture quality

You can adjust the picture quality (Contrast, Backlight, DynaLight™, Brightness, Color, Tint, and Sharpness.) to your personal preferences.

Selection	Pressing ◀	Pressing ▶
Contrast	lower	higher
Backlight*	darker	lighter
DynaLight**	On/Off	On/Off
Brightness	darker	lighter
Color	paler	deeper
Tint	reddish	greenish
Sharpness	softer	sharper

* Backlight

This feature adjusts the brightness of the entire screen. When in video mode and no signal is input, this will automatically be set to 0. (Settings are stored in memory.)

**DynaLight

This function automatically strengthens the black coloring of dark areas in the video according to the level of darkness.

To adjust the picture quality:

- 1 Press **SETUP** and open the **Picture** menu.
- 2 Highlight **Picture Settings** and press **OK**.
- 3 Press **▲** or **▼** to select the picture quality you want to adjust (**Contrast**, **Backlight**, **DynaLight**, **Brightness**, **Color**, **Tint**, or **Sharpness**), and then press **◀** or **▶** to adjust the setting, as described in the table above.
- 4 To save the new settings, highlight **Done** and press **OK**. You can use any of the picture modes (☞ “Selecting the picture mode” on page 37) as a starting point for adjusting the picture settings. To revert back to the base mode that you began adjusting the picture settings from, highlight **Reset** and press **OK**.

The picture qualities you adjusted are automatically saved in the **Preference** mode (☞ “Selecting the picture mode” on page 37) until **Reset** is selected.

Using the closed caption mode

Base closed captions

The closed caption mode has two options:

- **Captions**—An on-screen display of the dialogue, narration and sound effects of TV programs and videos that are closed captioned (usually marked “CC” in program guides).
- **Text**—An on-screen display of information not related to the current program, such as weather or stock data (when provided by individual stations).

To view captions or text:

- 1 Press **SETUP** and open the **Preferences** menu, highlight **Base CC Mode**.
 - 2 Press **◀** or **▶** to select the desired closed caption mode and press **CANCEL**.
- **To view captions:** Highlight **CC1**, **CC2**, **CC3**, or **CC4**. (**CC1** displays translation of the primary language in your area.)



Note: If the program or video you selected is not closed captioned, no captions will display on-screen.

- **To view text:** Highlight **T1**, **T2**, **T3**, or **T4**.

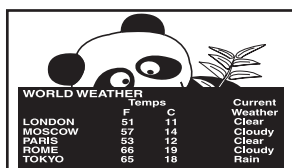

Note: If text is not available in your area, a black rectangle may appear on screen. If this happens, set the Base CC Mode to **Off**.

- **To turn off the closed caption mode:** Select **Off** in step 2 above.

Note: A closed caption signal may not display in the following situations:

- When a videotape has been dubbed.
- When the signal reception is weak.
- When the signal reception is non-standard.

(continued)

Digital CC Settings

You can customize the closed caption display characteristics by changing the background color, opacity, text size, type, edge, and color.

Note:

- This feature is available for digital channels only.
- You cannot set the Caption Text and Background as the same color.

To customize the closed captions:

- 1 Press **SETUP** and open the **Preferences** menu.
- 2 Highlight **Digital CC Settings** and press **OK**.
- 3 Press **▲** or **▼** to highlight the characteristic you want to change, and then press **◀** or **▶** to select the format for that characteristic (see table below).
- 4 To save the new settings, highlight **Done** and press **OK**. To revert to the factory defaults, highlight **Reset** and press **OK**.

Caption Size	Auto, Small, Standard, Large
Caption Text Type	Auto, Default, Mono w. Serif, Prop. w. Serif, Mono w/o Serif, Prop. w/o Serif, Casual, Cursive, Small Capitals
Caption Text Edge	Auto, None, Raised, Depressed, Uniform, Left Drop Shadow, Right Drop Shadow
Caption Text Color	Auto, Black, White, Red, Green, Blue, Yellow, Magenta, Cyan
Text Foreground Opacity	Auto, Transparent, Translucent, Flashing, Solid
Background Color	Auto, Black, White, Red, Green, Blue, Yellow, Magenta, Cyan
Text Background Opacity	Auto, Transparent, Translucent, Flashing, Solid
Caption Text Edge Color	Auto, Black, White, Red, Green, Blue, Yellow, Magenta, Cyan

CC Selector

You can use the **CC Selector** to temporarily override the default analog caption mode (set in **Base CC Mode**) for a particular channel. However, once you change to another analog channel, the closed caption setting will automatically change back to the current **Base CC Mode** setting.

You can also use the **CC Selector** to select digital closed caption services (if available). When such services are not available, the **CC Selector** presents a default list of services. If the selected service is not available, the next best service will be used instead.

To select closed captions:

- 1 Press **SETUP** and open the **Preferences** menu.
- 2 Highlight **CC Selector** and press **OK**.
- 3 Press **◀** or **▶** to select the desired service.
- 4 Press **CANCEL**.

Note: You can also press **SUBTITLE** to open **CC Selector** and follow from step 3.

Adjusting the audio

Muting the sound (For TV speakers)

Press **MUTE** on the remote control to partially reduce (1/2 MUTE) or turn off (MUTE) the sound. Each time you press **MUTE**, the mute mode will change in the following order:



If the closed caption mode is set to **Off** when you select “MUTE” mode, the closed caption feature is automatically activated if the TV program is Closed Captioned. To mute the audio without automatically activating the closed caption feature, use **VOL** to set the volume to 0. See “Using the closed caption mode” (page 38) for more information on closed caption modes.

Note: If you modify items in the **SOUND** menu while Mute is active, the Mute will automatically be canceled.

Using the digital audio selector

You can use the **Digital Audio Selector** to conveniently switch between audio tracks on a digital channel (for those channels that have multiple audio tracks). This temporarily overrides the audio track chosen by the language option under **Audio Setup** (see “Selecting stereo/SAP broadcasts” on page 40).

To use the digital audio selector:

- 1 Press **SETUP** and open the **Sound** menu.
- 2 Highlight **Digital Audio Selector** and press **OK**.

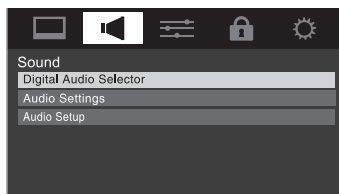



- 3 Press **◀** or **▶** to select the desired service.
- 4 Press **CANCEL**.





(continued)

Selecting stereo / SAP broadcasts

The multi-channel TV sound (MTS) feature allows you to output high-fidelity stereo sound. MTS also can transmit a second audio program (SAP) containing a second language, music or other audio information (when provided by individual stations).

When the TV receives a stereo or SAP broadcast, the symbol “” or word “SAP” appears on-screen when  is pressed. The MTS feature is only available for analog signals on the **ANT/CABLE** input.



To listen to stereo sound:

- 1 Press  and open the **Sound** menu.
- 2 Highlight **Audio Setup** and press .
- 3 In the **MTS** field, select **Stereo**.
- 4 To save the new settings, highlight **Done** and press . To reset the settings to the factory defaults, highlight **Reset** and press .

Note:

- You can typically leave the TV in **Stereo** mode because it will automatically output the type of sound being broadcast (stereo or monaural).
- If the stereo sound is noisy, select **Mono** to reduce the noise.

To listen to an alternate language on an ATSC digital station (if available):

Highlight the **Language** field in step 3 above, and then press  or  to select the language you prefer.

To listen to a second audio program on an analog station (if available):

Select **SAP** in step 3 above.

Note:

- A second audio program (SAP) can be heard only on those TV stations that offer it. For example, a station might broadcast another language as a second audio program. If you have SAP on, you will see the current program on the screen but hear the other language instead of the program's normal audio.
- If you have SAP on and the station you are watching is not broadcasting a second audio program, the station's normal audio will be output. However, occasionally there is no sound at all in **SAP** mode. If this happens, set the **MTS** feature to **Stereo** mode.

Using the MTS button

If you press  when an analog channel is tuned:

- The Analog Audio bar will appear and will display Stereo, SAP, Mono as the options.

If you press  when a digital channel is tuned:

- The Digital Audio bar will appear and will offer different audio choices for the digital channel.











If you press  when an external input is selected:

- No Audio bar is displayed.

Adjusting the audio quality

You can adjust the audio quality by adjusting the bass, treble and balance.





To adjust the audio quality:

- 1 Press  and open the **Sound** menu.
- 2 Highlight **Audio Settings** and press .
- 3 Press  or  to highlight the item you want to adjust (**Bass**, **Treble** or **Balance**).
- 4 Press  or  to adjust the level.
 -  makes the bass or treble weaker or increases the balance in the left channel (depending on the item selected).
 -  makes the bass or treble stronger or increases the balance in the right channel (depending on the item selected).
- 5 To save the new settings, highlight **Done** and press . To reset the settings to the factory defaults, highlight **Reset** and press .

Selecting the optical audio output format

You can use this feature to select the optical audio output format when you connect a Dolby Digital decoder or other digital audio system to the **Optical Audio Out** terminal on the TV (see “Connecting a digital audio system” on page 19).

To select the optical audio output format:

- 1 Press  and open the **Sound** menu.
- 2 Highlight **Audio Setup** and press .
- 3 In the **Optical Output Format** field, select either **Dolby Digital** or **PCM**, depending on your device.
- 4 To save the new settings, highlight **Done** and press . To revert to the factory defaults, highlight **Reset** and press .

(continued)

Using the Dolby® Digital Dynamic Range Control feature

This dynamic range control feature causes Dolby Digital dynamic range to be further compressed, allowing you to switch from digital to analog broadcasts at the same dynamic range.

To use the Dolby Digital Dynamic Range Control:

- 1 Press **SETUP** and open the **Sound** menu.
- 2 Highlight **Audio Setup** and press **OK**.
- 3 In the **Dolby Digital Dynamic Range Control** field, select **Compressed**. When **Standard** is selected, the audio is output with minimal compression.
- 4 To save the new settings, highlight **Done** and press **OK**. To revert to the factory defaults, highlight **Reset** and press **OK**.

Note:

- This feature is available when tuned to a digital RF channel with the Dolby Digital signal.
- The Dolby Digital Dynamic Range Control will function in relation to Optical Output Format (PCM mode).

Using the Locks menu

The Locks menu includes the Enable Rating Blocking, Edit Rating Limits, Input Lock, Panel Lock, GameTimer and New PIN Code features. You can use these features after entering the correct PIN code.

Entering the PIN code

- 1 Press **SETUP** and highlight the **Locks** menu icon.

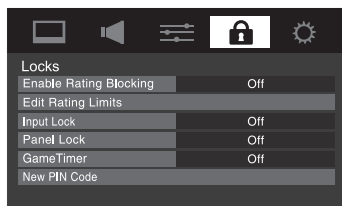

- 2 Press **▼**, which displays the PIN code entry screen.
 - The **Lock System** screen (Top right) appears if a PIN code has not been stored. Press the Channel

Number buttons to enter a new four-digit code, enter the code a second time to confirm, and press **OK**.

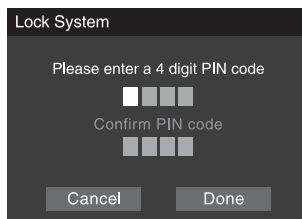

- The **Locks/Active** screen appears if the PIN code is already stored. Use the Number buttons to enter your four-digit code and press **OK**.

If the wrong PIN code is entered, the message “Incorrect PIN code, please try again!” appears.

Highlight **Retry** and press **OK**. Enter the code again and press **OK**.

When the correct PIN code is entered, the **Locks** menu opens.

Note:

PIN code cannot be set to “0000”.

If you cannot remember your PIN code

While the PIN code entering screen is displayed, press **DISPLAY** four times within five seconds. The PIN code will be cleared and you can enter a new PIN code.

Changing your PIN code

- 1 Press **SETUP** and highlight the **Locks** menu icon.
- 2 Press **▼** to display the PIN code entering screen.
- 3 Enter your four-digit PIN code and press **OK**.
- 4 Press **▼** to highlight **New PIN Code** and press **OK**.
- 5 Press the Number buttons to enter a new four-digit code. Reenter the PIN code to confirm it.
- 6 Press **OK**. The new PIN code is now active.

Note:

PIN code cannot be set to “0000”.

Blocking TV programs and movies by rating (V-Chip)

Some TV programs and movies include signals that classify the content of the program (violence, sex, dialog, language). The V-Chip feature in this TV detects the signals and blocks the programs according to the ratings you select. (For rating descriptions, see the tables on page 43.)

(continued)

To block and unblock TV programs and movies:

- 1 Press **SETUP** and highlight the **Locks** menu icon.
- 2 Press **▼** to display the PIN code entering screen.
- 3 Enter your four-digit PIN code and press **OK**.
- 4 Press **▼** to highlight **Enable Rating Blocking**.
- 5 Press **▶** to select **On**.

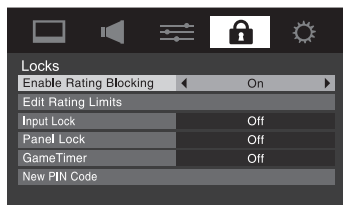

- 6 Press **▼** to highlight **Edit Rating Limits** and press **OK**. The **Edit Rating Limits** screen appears.
- 7 Press **▲▼◀▶** and then press **OK** to select the level of blocking you prefer. A box with an "X" is a rating that will be blocked. As you highlight a rating, a definition for the rating appears at the bottom of the screen.
- 8 When done selecting the ratings you want to block, highlight **Done** and press **OK**.

Note: Above selection of blocking level is for U.S V-Chip system. For Canada rating, you can highlight the "Canada RS" then press **OK**, another "Canadian Rating Menu" screen will appear.

Downloading an additional rating system for blocking TV programs and movies

In the future, an additional rating system may become available for use in selectively blocking programs.

Note: The currently tuned station must be receiving a digital signal before an additional rating system can be downloaded.

To download the additional rating system (if available):

- 1 Press **SETUP** and highlight the **Locks** menu icon.
- 2 Press **▼** to display the PIN code entering screen.
- 3 Enter your four-digit PIN code and press **OK**.
- 4 Press **▼** to highlight **Enable Rating Blocking**.
- 5 Press **▶** to select **On**.
- 6 Press **▼** to highlight **Edit Rating Limits** and press **OK**. The **Edit Rating Limits** screen appears.
- 7 Highlight **Alt RS** and press **OK**. The **Edit Alternate Ratings** screen will appear.

Note:

- The **Alt RS** button will only be available if an additional rating system is currently available.
 - It may take several minutes for the TV to download the additional rating system.
 - The information displayed in the **Alternate Ratings** screen will depend on the configuration of the additional rating system available at the time of download.
- 8 Press **▲▼◀▶** and then press **OK** to select the level of blocking you prefer. A box with an "X" is a rating that will be blocked.
 - 9 When you have finished selecting the ratings you want to block, highlight **Done** and press **OK**.
 - 10 In the **Edit Rating Limits** screen, highlight **Done** and press **OK**.

Note:

- The additional rating system can only be downloaded one time. You will not be able to download any updates to the rating system should such updates become available.
- The additional rating system is not designed, transmitted or controlled by the TV or Toshiba, nor is the availability of an additional rating system determined or controlled by Toshiba. Similarly, the rating of programs in an additional rating system is not determined, transmitted or controlled by the TV or Toshiba.
- The additional rating system is an evolving technology; therefore, availability, content and format may vary.

(continued)

Chapter 6: Using the TV's features

Independent rating system for broadcasters	
Ratings	Description and Content themes
TV-MA	Mature Audience Only (This program is specifically designed to be viewed by adults and may be unsuitable for children under 17.) L) Crude or indecent language S) Explicit sexual activity V) Graphic violence
TV-14	Parents Strongly Cautioned (This program contains some material that many parents would find unsuitable for children under 14.) D) Intensely suggestive dialog L) Strong, coarse language S) Intense sexual situations V) Intense violence
TV-PG	Parental Guidance Suggested (This program contains material that parents may find unsuitable for younger children.) D) Some suggestive dialog L) Infrequent coarse language S) Some sexual situations V) Moderate violence
TV-G	General Audience (Most parents would find this program suitable for all ages.)
TV-Y7, TV-Y7FV	Directed to Older Children (This program is designed for children age 7 and above. Note: Programs in which fantasy violence may be more intense or more combative than other programs in this category are designated TV-Y7FV.)
TV-Y	All Children (This program is designed to be appropriate for all children.)

Independent rating system for movies	
Ratings	Description and Content themes
X	X-rated (For adults only)
NC-17	Not intended for anyone 17 and under
R	Restricted (Under 17 requires accompanying parent or adult)
PG-13	Parents Strongly Cautioned (Some material may be inappropriate for children under 13)
PG	Parental Guidance Suggested (Some material may not be suitable for children)
G	General Audience (Appropriate for all ages)

Note:













- If you place an "X" in the box next to "None" Rated programs rated "None" will be blocked; however, programs that do not provide any rating information will not be blocked.

- To display the rating of the program you are watching, press  on the remote control. If it is rated "None" the word "NONE" appears in the **INFO** screen (as shown below right). If rating information is not provided, no rating will appear in the **INFO** screen.

TV - PG L V

NONE

Blocking TV programs by Canada rating :

- Press  and highlight the **Locks** menu icon.
- Press  to display the PIN code entering screen.
- Enter your four-digit PIN code and press .
- Press  to highlight **Enable Rating Blocking**.
- Press  to select **On**.
- Press  to highlight **Edit Rating Limits** and press . The **Edit Rating Limits** screen appears.
- Highlight **Canada RS** and press . The **Canadian Raging Menu** will appear.
- Press  and then press  to select the level of blocking you prefer. A box with an "X" is a rating that will be blocked.
- When you have finished selecting the ratings you want to block, highlight **Done** and press .
- In the **Edit Rating Limits** screen, highlight **Done** and press .

English	
Ratings	Description and Content themes
E	Exempt shows
C	Children ages of 2 to 7 years
C8+	Children 8 years and older
G	General programming
PG	Parental Guidance
14+	Viewers 14 and older
18+	Adult programming

French	
Ratings	Description and Content themes
E	Exempt shows
G	General programming
8 ans+	Not recommended for ages under 8
13 ans+	Not recommended for ages under 13
16 ans+	Not recommended for ages under 16
18 ans+	Programming restricted to adults

(continued)

Unlocking programs temporarily

If you try to tune the TV to a program that exceeds the rating limits you set, the TV will enter program lock mode and the following message will appear on-screen:

This program exceeds the rating limit you set.
Push 'MUTE' to enter PIN.

You can either temporarily unlock the program or select an unlocked program to watch.

To temporarily unlock the program:

- 1 Press **MUTE** .
- 2 Enter your four-digit PIN code and press **OK**.
If the correct code is entered, the program lock mode is released and the normal picture appears. All locking will be enabled when the TV change channel.

Using the input lock feature

You can use the Input Lock feature to lock the video inputs (**Video**, **ColorStream HD**, **HDMI 1**, **HDMI 2**, and **PC**) and channels 3 and 4. You will not be able to view the input sources or channels until you unlock the inputs.

To lock/unlock the video inputs:

- 1 From the **Locks** menu, Press **▼** to display the PIN code entering screen.
- 2 Enter your four-digit PIN code and press **OK**.
- 3 Press **▼** to highlight **Input Lock** and press **▶** to select the level of video input locking you prefer, as described below.

Mode	Description
Video	Locks Video, ColorStream HD, HDMI 1, HDMI 2 and PC.
Video+	Locks Video, ColorStream HD, HDMI 1, HDMI 2, PC and channels 3 and 4. <ul style="list-style-type: none"> • Select Video+ if you play video tapes via an ANT/CABLE input.
Off	Unlocks all video inputs and channels 3 and 4.

- 4 Press **CANCEL** .

Locking channels

With the Lock feature, you can lock specific channels. The locked channels can only be accessed by entering the PIN.

To lock channels:

- 1 From the **Setup** menu, highlight **Installation** and press **OK**.
- 2 Press **OK** to select **Terrestrial**.
- 3 Press **▲** or **▼** to select **Channel Options** and press **OK**. The list of channels will appear.

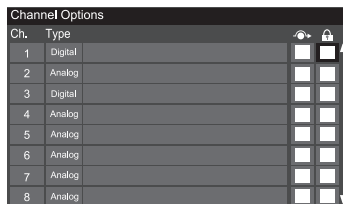

- 4 Press **▶** and then **▲** or **▼** to select a channel in the lock column.
- 5 Press **OK**. PIN code entry will be required to set a locked channel.
Note: If the PIN code has not been set yet, a warning message will appear.
- 6 A tick will appear in the box.
To remove the tick, press **OK** again.
- 7 Press **CANCEL** .

Using the GameTimer®

You can use the GameTimer to set a time limit for playing a video game (30–120 minutes). When the GameTimer expires, the TV enters Input Lock mode and locks out the input source for the video game device.

To set the GameTimer®:

- 1 From the **Locks** menu, press **▼** to display the PIN code entering screen.
- 2 Enter your four-digit PIN code and press **OK**.
- 3 Press **▼** to highlight **GameTimer** and press **▶** to select the length of time until the Input Lock is activated (30, 60, 90 or 120 minutes).

To cancel the GameTimer®:

Select **Off** in step 3 above.

To deactivate the Input Lock once the GameTimer® has activated it:

Set the **Input Lock** to **Off** (⏻) “Using the input lock feature” as described).

Note:

- A message will appear when 10 minutes, 3 minutes, and 1 minute remain on the GameTimer.
- If the TV loses power with time remaining on the GameTimer, when power is restored the TV will enter Input Lock mode (as if the GameTimer had been activated) and you will have to deactivate the Input Lock (as described before).

(continued)

Using the panel lock feature

You can lock the control panel to prevent your settings from being changed accidentally (by children, for example). When the **Panel Lock** is **On**, none of the controls on the TV control panel will operate except **POWER**.

To lock the control panel:

- 1 Press **SETUP** and highlight the **Locks** menu icon.
- 2 Press **▼** to display the PIN code entering screen.
- 3 Enter your four-digit PIN code and press **OK**.
- 4 Press **▼** to highlight **Panel Lock**.
- 5 Press **▶** to select **On**. When the control panel is locked and any button on the control panel (except **POWER**) is pressed, the message "NOT AVAILABLE" appears.

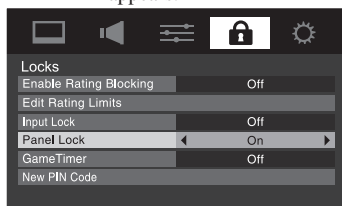

To unlock the control panel:

Select **Off** in step 5 above, or press and hold the **VOLUME –** button on the TV control panel for about 10 seconds until the volume icon appears.

Using the PC settings feature

You can view an image from a PC on the TV screen. When a PC is connected to the TV's PC IN terminal, you can use the PC Settings feature to make adjustments to the image. If the edges of the picture are cut off, readjust the **Horizontal Position** and **Vertical Position**. If the picture is affected by interference, readjust the **Clock Phase** and **Sampling Clock**.

To adjust the PC settings:

- 1 Repeatedly press **INPUT** to select PC input mode (see "Selecting the video input source to view" page 30).
- 2 Press **SETUP** and open the **Setup** menu.
- 3 Highlight **PC Settings** and press **OK**.

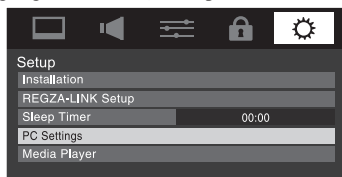

Note: If a PC is not connected or there is no pc input signal, this feature will be grayed out in the **Setup** menu.

- 4 Press **▲** or **▼** to highlight the item you want to adjust.
- 5 Press **◀** or **▶** to make the appropriate adjustments.

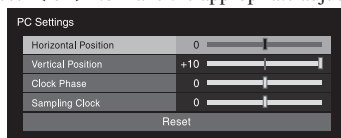

Note: The screen is disrupted momentarily when adjusting the PC settings. This is not a sign of malfunction.

Mode	Description
Horizontal Position	Moves the picture left/right. The adjustment range is within ± 10 from center.*
Vertical Position	Moves the picture up/down. The adjustment range is within ± 10 from center.*
Clock Phase	Helps to reduce noise and sharpen the picture. The adjustment range is within ± 16 from center.*
Sampling Clock	Helps to reduce noise and minimize periodic vertical stripes on the screen. The adjustment range is within ± 10 from center.*
Reset	Highlight this item then press OK to get an optimum adjustment automatically.

* The default settings may vary depending on the input signal format.

Setting the PC Audio

This function allows you to output or mute the sound from your PC when connecting using the PC IN terminal and an analog RGB cable. (see page 20)

To set the PC Audio:

- 1 Press **SETUP** and open the **Sound** menu.
- 2 Highlight **Audio Setup** and press **OK**.
- 3 Press **▲** or **▼** to select **PC Audio** and then press **◀** or **▶** to select **No** or **Yes**.

Yes: When viewing the PC input, the audio from the PC Audio input can be heard.

No: When viewing the PC input, there will be no audio.

Note: Because the PC and HDMI-1 inputs share the same set of analog audio inputs, the **PC Audio** menu setting influences the **HDMI 1 Audio** menu setting. If **PC Audio** is set to "No" the **HDMI 1 Audio** setting changes to "Auto" If **PC Audio** is set to "Yes" the **HDMI 1 Audio** setting is set to "Digital" and is grayed out in the menu. (Also see item 3 on page 13 and "Setting the HDMI® audio mode" on page 28.)

Using the Media Player

Using the Media Player with USB

You can enjoy photos or music contents stored on a USB storage device.

Photo Viewer specifications:

Data type: JPEG Exif ver2.1
 File format: JPEG
 Maximum photo size: 6 MB
 Maximum number of files: 500 / folder
 Maximum photo resolution: 4096 x 4096 pixels
 Best photo resolution:
 1366 x 768 pixels (19SLV411U, 32SLV411U)
 1920 x 1080 pixels (24SLV411U)

Music Player specifications:

File format: MP3
 Sampling frequency: 16 kHz, 22.05 kHz, 24 kHz,
 32 kHz, 44.1 kHz, 48 kHz
 Bit rate: from 8 to 320 kbps
 Maximum number of files: 500 / folder

Supported file system:

FAT16 and FAT32

Note:

- Gently insert the USB device into the port and do not remove while viewing Media Player.
- USB device: USB Mass Storage Class device (MSC)
- Connectivity is not guaranteed for all devices.
- Connect the USB device to the TV directly.
- Do not use a USB Hub.
- You must obtain any required permission from copyright owners to use copyright content. Toshiba cannot and does not grant such permission.
- Depending on the file size and amount in your USB storage device, it may take some time for loading to view. A message will display on-screen when loading files from the USB storage device.
- Only limited types of U3 USB device are supported. Therefore, it is suggested not to use U3 USB for playing Media Player.
- Non-supported characters will be replaced with a square (□).

To select the Auto Start function

- 1 Press **SETUP** and ◀ or ▶ to select the **Setup** menu.
- 2 Press ▼ to select **Media Player**, and then press **OK**.
- 3 Press ▲ or ▼ to select **Auto Start**.
- 4 Press ◀ or ▶ to select **On** or **Off**.

To open the Media Player

There are two kinds of methods to open the Media Player.

Automatically open:

- 1 Gently insert a supported USB storage device to the USB port on the rear side of the TV. A prompt will appear.

Note: If you repeatedly insert and remove the USB connector, the prompt may not appear.

- 2 Press ◀ or ▶ to select **Yes**, and then press **OK**. The **Media Player** menu will appear. When you select **No**, nothing happens.

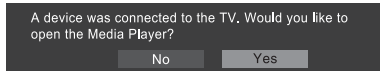

Note:

- The prompt will disappear after about 10 sec.
- If **Auto Start** is set to off, you can start the Media Player manually.

Manually open:

- 1 Press **SETUP** and ◀ or ▶ to select the **Setup** menu.
- 2 Press ▼ to select **Media Player**, and then press **OK**.
- 3 Press ▲ or ▼ to select **Photo** or **Music** then press **OK**.



Note:

- The viewer will also open even if there are no photo or music files.
- While the Media Player is active, the main menus cannot be displayed.

(continued)

Viewing photo files

There are three types of view modes.

Multi View:

This view allows you to search for photos in a grid format. These pictures are displayed using thumbnail data in each image file.

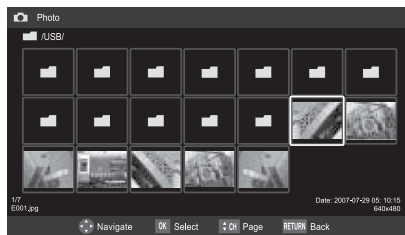

1 Press \blacktriangle \blacktriangledown \blacktriangleleft \blacktriangleright to move the highlight in one window. If all of the photos will not fit in one screen, when pressing \blacktriangleleft at the top left thumbnail, the screen will move to the previous page. Conversely, when pressing \blacktriangleright at the bottom right thumbnail, the screen will move to the next page. $\boxed{\blacktriangle}$ / $\boxed{\blacktriangledown}$ / $\boxed{\blacktriangleleft}$ / $\boxed{\blacktriangleright}$ buttons can be used to page up/down the photo list when there are more photos than will fit onto one screen.

2 When you select a folder, press OK to move to the next layer. Press RETURN to move back to the previous layer.

3 Press OK to view the selected photo in Single View mode.

Single View

In this view mode, only files located in the selected directory shall be displayed. This view allows you to change the photo content manually. When moving from Multi View to the Single View, the currently selected photo shall be displayed.

1 Press \blacktriangleright to view the next photo. Press \blacktriangleleft to view the previous photo.

2 Press \blacktriangle to rotate the image 90° counterclockwise. Press \blacktriangledown to rotate the image 90° clockwise.

Slide Show

This view allows you to watch a slide show of the photos. In this mode, only files located in the selected directory will be played.

1 To start slide show, press OK in the Single View mode.

2 Press \blacktriangleleft or \blacktriangleright to view the previous or next photo.

To set Interval Time and Repeat settings:

1 Press SETUP to open the **Quick Menu**.

2 Press \blacktriangle or \blacktriangledown to select either **Interval Time** or **Repeat**.

3 Press \blacktriangleleft or \blacktriangleright to adjust the setting and press RETURN .

Note: Zoom and Picture size functions are disable.

To close the Photo Viewer

1 Press CANCEL . The television will return to the last viewed channel or external input.

Playing music files

You can listen to music from a list of available files.

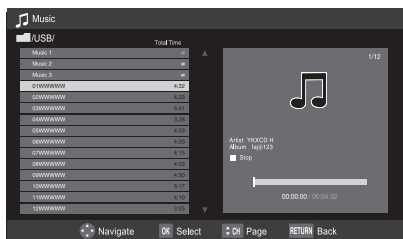

1 Press \blacktriangle or \blacktriangledown to select a file or folder. $\boxed{\blacktriangle}$ / $\boxed{\blacktriangledown}$ buttons can be used to page up/down the music list when there are more files than will fit onto one screen.

2 When you select a folder, press OK to move to the next layer. Press RETURN to move back to the previous layer.

3 With the desired file selected, press OK or PLAY to start playback.







4 Press STOP to stop playback.

Note:

- If playback finishes before STOP is pressed, the next file will automatically start to play from the beginning.
- Depending on the file size, it may take some time for playback to begin.

(continued)



During playback

- Press **PAUSE**  to pause.
- To normal playback, press **PLAY**  or **PAUSE** .
- To locate a specific file, press **SKIP**  or **SKIP**  repeatedly.
- To adjust volume, press **Vol.**  / **Vol.** .

Note:

During playback, you can adjust the **SOUND** menu functions from the **Quick Menu**.

To set the repeat mode:





- 1** Press **SETUP**  to open the **Quick Menu**.
- 2** Highlight **Repeat**, and press **◀** or **▶** to select **Off**, **All** or **1**.
- 3** Press **RETURN** .

To close the Music Player

- 1** Press **CANCEL** .

Viewing photo files with playing music files at the same time

While viewing photo files, this allow you to listen to music from a list of available files.

- 1** While viewing photo in the **Single View** or **Slide Show** mode, press **SETUP**  to open the **Quick Menu**.
- 2** Highlight **Background Music** and press **OK** , the music list will appear.
- 3** Select a music file and press **OK**  to start playback.
- 4** Press **RETURN**  twice to move back the photo view mode, now the music is playing in the background.

Contents	Description	Description
Photo	Photo list (Multi View)	See page 47.
	Sorting	
	To sort the folders and files	
	1 Press SETUP  to open the Quick Menu from Multi View mode.	
	2 Press ▲ or ▼ to select Sort .	
	3 Press ◀ or ▶ to select Title , New or Old to set the sorting rule.	
	Title --File sorting rules:	
	1 Unicode priority	
	2 (0, 1, ..., 9), capital alphabet (A, B, ..., Z), small alphabet (a, b, ..., z), Chinese	
	3 Increasing order	
New --From new to old according to the date and time when the picture was taken.		
Old --From old to new according to the date and time when the picture was taken.		
Single View mode	See page 47.	
Slide Show mode	See page 47.	
Skip to previous/next photo	See page 47.	
Slide Show Repeat play	See page 47.	
Slide Show Interval Time selection	See page 47.	

(continued)



Contents	Description	Description
Music	Music list (Multi View)	See page 47.
	Sorting	
	To sort the folders and files	
	1	Press  to open the Quick Menu .
	2	Press ▲ or ▼ to select Sort .
	3	Press ◀ or ▶ to select Title, New or Old to set the sorting rule.
	Playback	See page 47.
	Pause	See page 48.
	Stop	See page 47.
	Skip	See page 48.
Repeat play	See page 48.	
SOUND Settings ("Adjusting the audio quality")	See page 40.	

Note: *Sorting, Total Time display may not be available in all cases.*



Setting the sleep timer

You can set the sleep timer to turn off the TV after a set length of time (maximum of 12 hours).

To set the sleep timer using the remote control:

Press  on the remote control to set the length of time until the TV turns off. Repeatedly press  to increase the time in 10-minute increments, or press **▲** or **▼** to increase or decrease the time in 10-minute increments, to a maximum of 12 hours.

To set the sleep timer using the on-screen menus:

- 1** Press  and open the **Setup** menu.
- 2** Highlight **Sleep Timer**.
- 3** Press the Number buttons to enter the length of time (maximum of 12 hours) and then press . Or press **◀** or **▶** to increase or decrease in 10-minute increments (maximum of 12 hours).

Note: *When a power failure occurs, the sleep timer setting may be cleared.*

To display the remaining sleep time:

Press .



Note: *A message will display on-screen when there is one minute remaining on the sleep timer.*

To cancel the sleep timer:

Repeatedly press  until it is set to 0 minute.

Automatic Power Down

The TV will automatically turn itself off (standby) after 4 hours, if you do not operate the TV either from the remote control or the TV control panel.

- 1** From the **Preferences** menu, highlight **Energy Saving Settings** and press .
- 2** Press **▲** or **▼** to select **Automatic Power Down**.
- 3** Press **◀** or **▶** to select **On** or **Off**, and press .

Note:

- *The initial setting of this feature is **Off**.*
- *1 minute before switching to standby, a warning message will appear.*
- *When the following features are set, the feature that is set for the nearest time will function.*

–Automatic Power Down

–Sleep Timer



–No signal auto power off (after 15 minute of no signal).

No Signal Power Down

The TV will automatically turn itself off after 15 minutes when no signal is detected.

You can change the setting to Off for the following purposes:

- Low signal strength of analog channel (no signal detection)
- Only Audio L/R is connected to external input to listen to music through the TV speakers.

- 1** From the **Preferences** menu, highlight **Energy Saving Settings** and press .
- 2** Press **▲** or **▼** to select **No Signal Power Down** and press .
- 3** Press **▲** or **▼** to highlight the item you want to change, and press **◀** or **▶** to select **On** or **Off**.

Note:

- *Default setting is all **On**.*
- *A warning message will appear 1 minute before turning off.*

Using REGZA-LINK®











This is a new feature that uses CEC technology and allows you to control Toshiba REGZA-LINK® compatible devices from the TV remote via HDMI connection (see page 18).

When the **Enable REGZA-LINK** in the **REGZA-LINK Setup** menu is set to **On**, the following REGZA-LINK® functions will be enabled.

REGZA-LINK® playback device (DVD player, etc.) control

With your TV's remote control, or using the **REGZA-LINK Player Control** menu, you can control the connected REGZA-LINK® playback device you are watching.

Available remote control key functions:

Button	Description
	Begins playback.
	Stops playback.
	Pauses the picture during play or record mode.
	Skips forward.
	Skips backward.
	Fast-forwards.
	Rewinds/reverses.
	Navigate contents menu, etc.
	Enters contents menu, etc.
	Returns to the previous menu.

Note: These functions depend on the devices connected.

REGZA-LINK Player Control menu functions:

- 1 Press **SETUP** and open the **Preferences** menu.
- 2 Highlight **REGZA-LINK Player Control** and press **OK**.

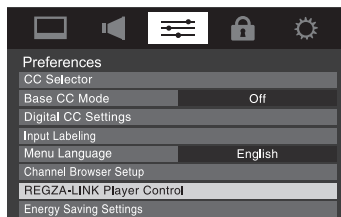

- 3 Press **▲** or **▼** to select the item you want to control and press **OK**.

Item	Description
Power	Turns the select device on and off.
Root Menu	Accesses the top menu of the selected device.
Contents Menu	Accesses the contents list when you press OK . At this time, the REGZA-LINK Player Control menu will disappear.
Setup Menu	Accesses the setup menu of a DVD player.
Top Menu	Accesses the top menu of a DVD.
Menu	Accesses the menu of a DVD.

Note:

- These functions depend on the devices that are connected.
- The **REGZA-LINK Player Control** item will be grayed out in the following conditions:
 - A non-HDMI input is currently selected.
 - The **Enable REGZA-LINK** item is set to **Off**.
 - The connected CEC device is not a playback or recording device.



REGZA-LINK® input source selection

If a REGZA-LINK® device with HDMI switching capability (e.g. Audio Receiver) is connected to the HDMI input, you can select another REGZA-LINK® device that is connected to the master HDMI device using the TV's INPUT button. See page 30 for details.

(continued)

VOLUME and MUTE controls of Audio Receiver

With your TV's remote control, you can adjust or mute the sound volume of the Audio Receiver.

-  adjust the volume level.
-  turns off the sound.

Note:

- To use this function:
 - Set **Speaker Preference** to **Audio Receiver** in the **REGZA-LINK Setup** menu.
 - Confirm that a connected REGZA-LINK® device (such as DVD player, etc) is selected for the Audio Receiver input source.
- You can also use this function when the audio receiver is connected to the TV's **DIGITAL AUDIO OUT** terminal (not HDMI connection). In this case, select a digital audio input mode on the Audio Receiver.
- These functions depend on the device connected.





Other REGZA-LINK® functions







When the **Enable REGZA-LINK** and each item in the **REGZA-LINK Setup** menu are set to **On**, the following functions will be enabled.

Item	Description
TV Auto Input Switch	If a connected HDMI device starts playing video or audio, the TV will automatically switch to the appropriate HDMI input.
TV Auto Power	If a REGZA-LINK® device is turned on, the TV turns on automatically.
Device Auto Standby	If the TV is turned off the TV will send a message to turn off all of the REGZA-LINK® devices connected to the TV.
Speaker Preference	From this item, you can set your audio output preference to the TV speakers or the audio receiver speakers. When this item is set to Audio Receiver, the TV remote can be used to adjust or mute the volume of the audio. This item will be grayed out unless a REGZA-LINK® compatible audio receiver is connected.

Note: When you turn on the Audio Receiver, change its input source or adjust the sound volume, the sound will be output from the audio receiver's speakers even if **TV Speakers** has been selected. Turn the TV off and on again to output the sound from the TV speakers.

To set the REGZA-LINK® Setup:

- 1 From the **Setup** menu, highlight **REGZA-LINK Setup** and press .
- 2 Press  or  to highlight **Enable REGZA-LINK**.
- 3 Press  or  to select **On**.

Note: If you select **Enable REGZA-LINK Off**, the other items will be grayed out.
- 4 Press  or  to highlight the **REGZA-LINK Setup** item you want to use, and press  or  to select **On** or desired mode.
 - TV Auto Input Switch: On/Off
 - TV Auto Power: On/Off
 - Device Auto Standby: On/Off
 - Speaker Preference: TV Speakers/Audio Receiver
- 5 To save the new settings, highlight **Done** and press . To revert to the factory defaults, highlight **Reset** and press .

Displaying TV status information

To display TV status information :

Press  on the remote control.



The following information will display (if applicable):

- Current input (**ANT/CABLE, VIDEO**, etc.)
- If ANT/CABLE is the current input, either “CABLE” (for cable TV) or “ANT” (for over-the-air broadcasts).
- Channel number (if in **ANT/CABLE** mode)
- Channel label (if applicable)
- Digital signal strength indicator (bar graph in lower right corner of box; for ATSC signal only)
- Stereo, Mono or SAP audio status (when HDMI input mode, Dolby Digital or PCM)
- Video resolution
- Aspect ratio of incoming video signal (4:3 or 16:9)
- V-Chip rating status
- GameTimer (if set)

To close the screen (except ANT/CABLE input):

Press  again.

The following additional information will display for ANT/CABLE input (if applicable):

- Title
- Duration
- Detailed description
- To display next program information for digital channels, press  again. Pressing  a third time will remove the entire banner.

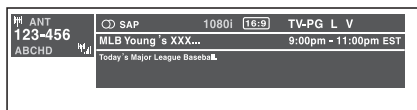

Note: The location of the banner can be moved to the top or bottom of the screen by pressing ▲ or ▼ while the INFO display is on-screen.

Understanding the auto power off feature

The TV will automatically turn itself off after approximately 15 minutes if it is tuned to a vacant channel or a station that completes its broadcast for the day.

Note:

- If you want to set this feature to off, see “No Signal Power Down” on page 49.
- If it is possible that you will be away from the TV for an extended period of time, you should unplug the power cord.

Understanding the last mode memory feature

If the power is cut off while you are viewing the TV, the Last Mode Memory feature automatically turns on the TV when the power is resupplied.

Note: If it's possible, and you will be away from the TV for an extended period of time you should unplug the power cord.

Using the advanced picture settings features

Using Dynamic Contrast

Dynamic Contrast detects changes in picture quality that affect the appearance of your contrast settings and then automatically adjusts the video.

To select Dynamic Contrast preference:

- 1 From the the **Picture** menu, highlight **Picture Settings** and press **OK**.

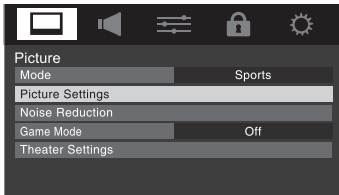

- 2 Highlight **Advanced Picture Settings** and press **OK**.
- 3 Press **▲** or **▼** to select **Dynamic Contrast**.
- 4 Press **◀** or **▶** to select **High, Middle, Low** and **Off**.

Using the Static Gamma feature

The Static Gamma feature allows you to adjust the levels of black in the picture.

To adjust the Static Gamma settings:

- 1 Press **SETUP** and open the **Picture** menu.
- 2 Highlight **Picture Settings** and press **OK**.
- 3 Highlight **Advanced Picture Settings** and press **OK**.
 - In the **Static Gamma** field, press **◀** or **▶** to adjust the Static Gamma. The adjustment range is within ± 5 from center.
 - If the setting is moved in the minus direction, the detail of black colors will be decreased.
 - If the setting is moved in the plus direction, the detail of black colors will be increased.
- 4 To save the new settings, highlight **Done** and press **OK**. To revert the factory defaults, highlight **Reset** and press **OK**.

Note: If you select one of the factory-set picture modes (**Sports, Standard, Movie** or **PC**) and then change the Static Gamma setting, the picture mode automatically changes to **Preference**.

Selecting the Color Temperature

You can change the quality of the picture by selecting from three preset Color Temperatures (Cool, Medium, and Warm), as described below.

Mode	Picture Quality
Cool	blueish
Medium	neutral
Warm	reddish

To select the Color Temperature:

- 1 Press **SETUP** and open the **Picture** menu.
- 2 Highlight **Picture Settings** and press **OK**.
- 3 Highlight **Advanced Picture Settings** and press **OK**.
- 4 Highlight **Color Temperature** and press **OK**.
- 5 In the **Color Temperature** field, press **◀** or **▶** to select the mode you prefer (**Cool, Medium, or Warm**).
- 6 Press **▲** or **▼** to select either **B Drive** or **G Drive**, and then press **◀** or **▶** to adjust the settings.
 - **B Drive:** **▶** makes the picture blueish.
 - **G Drive:** **▶** makes the picture greenish.
- 7 To save the new settings, highlight **Done** and press **OK**. To revert to the factory defaults, highlight **Reset** and press **OK**.

Note: If you select one of the factory-set picture modes (**Sports, Standard, Movie, or PC**) and then change the **Color Temperature** mode, the picture mode automatically changes to **Preference**.

(continued)

Using CableClear® digital Noise Reduction

The CableClear® digital Noise Reduction feature allows you to reduce visible interference in your TV picture. This may be useful when receiving a broadcast with a weak signal (especially a Cable channel) or playing a noisy video cassette or disc.

To change the CableClear settings:

- 1 Press **SETUP** and open the **Picture** menu, highlight **Noise Reduction** and press **OK**.
- 2 In the **CableClear** field, select your desired setting.
Note:
 - If the current input is **ANT/CABLE** or **VIDEO**, the menu will display the text "CableClear". The available selections are **Off**, **Low**, **Middle**, and **High**.
 - If the current input is **ColorStream HD**, **HDMI 1** or **HDMI 2**, the menu will display the text "DNR". The available selections are **Off**, **Low**, **Middle**, and **High**. **Low**, **Middle**, and **High** will reduce the noise in varying degrees, from lowest to highest, respectively.
- 3 To save the new settings, highlight **Done** and press **OK**.
To revert to the factory defaults, highlight **Reset** and press **OK**.

Using MPEG Noise Reduction

The MPEG Noise Reduction feature allows you to reduce visible interference caused by MPEG compression. Choices for MPEG Noise Reduction are **Off**, **Low**, **Middle**, and **High**. **Off** is automatically selected when this feature is disabled ("grayed out").

To select the MPEG Noise Reduction level:

- 1 Press **SETUP** and open the **Picture** menu.
- 2 Highlight **Noise Reduction** and press **OK**.
- 3 Press **▲** or **▼** to highlight the **MPEG Noise Reduction** field and then press **◀** or **▶** to select either **Off**, **Low**, **Middle** or **High**.
- 4 To save the new settings, highlight **Done** and press **OK**.
To revert to the factory defaults, highlight **Reset** and press **OK**.

Using the Game Mode feature

You can use the Game Mode feature for shorter frame delays when playing a video game requiring split-second timing between the on-screen display and input from the controller (such as music creation and high-action games).

This feature is more effective for 480i and 1080i input signals.

Note: To use the Game Mode feature, the current video input must be **Video**, **ColorStream HD**, **HDMI 1** or **HDMI 2**. The Game Mode cannot be turned on when any other video input, other than the above mentioned is selected.

To turn on Game Mode:

- 1 Press **SETUP** and open the **Picture** menu, then highlight the **Game Mode**.
- 2 Press **◀** or **▶** to select **On**.

To turn off Game Mode:

Select **Off** in step 2 above, change the video input, or turn the TV off and then on again.

Note: You can change the video input by pressing **INPUT** on the remote control (see page 30).

Disc playback

This section shows you the basics on how to play a disc.

Basic playback (DVD/VCD/CD)*

- 1 Press **POWER** on the TV control panel or on the remote control.
The Power LED on the front of the LCD TV / DVD combination changes to green. It may take approximately 10 seconds for a picture to appear on-screen.
When using an amplifier, switch on the amplifier.
- 2 Press **T.V/D.V/D** on the remote control to switch to DVD mode.
The DVD start-up screen will appear on-screen.

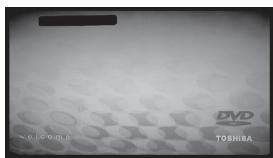

- 3 Hold the disc by its edges and load it in the disc slot with the label side facing forward.
The prompt “Insert Disc” changes to “Reading” and then playback starts.

Note: DO NOT touch the surface of the disc. This may leave a smudge that can cause playback errors.

If the disc has its own menu, it will be displayed on-screen. Press ▲ ▼ ◀ ▶ on the remote control to navigate the disc menu, then press **OK** to implement the selected menu option.

To adjust playback volume:

Press **Vol.** / **Vol.**.

To temporarily suspend disc playback (still mode):

Press **PAUSE**.

To continue playback from still mode:

Press **PLAY**.

To stop playback:

Press **STOP**.

Playback resume function:

Your LCD TV / DVD combination supports playback resume function.

If you stopped the disc playback before it is completed, the LCD TV / DVD combination records the stop point.

“**▶**” appears on-screen. Press **PLAY** to resume playback on the stop point. If you press **STOP** twice in quick succession or unload the disc, the LCD TV / DVD combination will clear the stop point.

Higher quality picture:

High resolution pictures on some discs may occasionally cause noise on the picture display. If this is the case, reduce the **Sharpness** setting under the **Picture Settings** menu (see page 38).

Note:

- Keep your fingers well clear of the disc slot when a disc is loading or unloading. Failure to do so may cause serious personal injury.
- Do not move the TV during playback. Doing so may damage the disc.
- When a disc is inserted when the TV is not in DVD mode, the TV will automatically switch to DVD mode.

* This indicates the kind of disc that can employ the function described under that heading.

DVD : You can use this function with DVDs.

VCD : You can use this function with Video CDs.

CD : You can use this function with Audio CDs and CD-R/RW discs.

Removing a disc

- 1 Press **EJECT** on the TV control panel or on the remote control.
- 2 Wait for the disc to be ejected and then remove the disc from the slot.

Disc playback reminders

- If the LCD TV / DVD combination does not operate properly, static electricity build-up may be the cause. Turn off the LCD TV / DVD combination, then disconnect the power cord from the AC outlet. Reconnect the power cord, then press **POWER** to turn on the LCD TV / DVD combination again.
- If an incompatible disc is loaded, one of the following error messages appears on-screen: “Incorrect Disc”, “Disc region incorrect” or “Enter Password”. If this is the case, check your disc again. Go to page 8 for a list of supported disc formats and to page 73 for playback-related troubleshooting instructions.

(continued)

- In some instances the LCD TV / DVD combination may take a minute or so to start disc playback.
- When you load a disc with the playback side facing backward, “Reading” appears on-screen but it will be replaced by “Incorrect Disc”. Eject the disc and load it again making sure the playback side is now facing forward.
- The playback resume function may not work on some discs.
- Some DVDs may have fixed playback operations designed by the DVD manufacturer. Your LCD TV / DVD combination follows this fixed playback design. In such cases, some playback features may not be available. You may refer to the instructions accompanying the DVD.
- Do not put any objects other than compatible discs on the disc slot. Doing so may cause damage to the LCD TV / DVD combination.
- There may be a few seconds between the action of pressing a button and the function it activates.

Playback navigation

Playing in fast reverse or fast forward direction (DVD/VCD/CD)

- 1 Press  or  during playback.

 : Fast reverse playback

 : Fast forward playback

Each time you press  or , the playback speed changes.

To resume normal playback:

Press .

Note:

- The sound is muted during reverse and forward scan.
- The playback speed may differ depending on the disc.
- You can use fast reverse/fast forward playback for MP3 and WMA CDs.

Playing frame by frame (DVD/VCD)

- 1 Press  during playback.

Each time you press , the picture advances one frame.

To resume normal playback:

Press .

Note:



- The sound is muted during frame by frame playback.

Playing in slow motion (DVD/VCD)

- 1 Press  or  during playback.

 : Slow reverse playback

 : Slow forward playback

Each time you press  or , the slow motion speed changes.



To resume normal playback:

Press .

Note:

- The sound is muted during slow motion playback.

Locating a chapter or track (DVD/VCD/CD)

- 1 Press  or  repeatedly to locate the previous or next chapter or track you want to play.

 : To locate succeeding chapters or tracks.

Playback starts from the beginning of the selected chapter or track.

 : Playback starts from the beginning of the current chapter or track.

When you press  twice in quick succession, playback starts from the beginning of the preceding chapter or track.

Zoom function/Scene navigation

You can change the viewing scale of a picture by using the Zoom function. Once the image has been rescaled, use the arrow buttons **▲▼◀▶** to pan the image.

Scene navigation options differ depending on the kind of disc. DVDs use the title, chapter or record time to locate the start point for playback. Audio CDs and Video CDs use the record time or track number. To view the discs title/track or chapter/ track list, press **DISPLAY** **INFO**.

Using Zoom (DVD/VCD)

- 1 Press **ZOOM** during playback. The view will zoom into the center of the image. Each press **ZOOM** of will increase the scale value: **Q 1** (× 1.3), **Q 2** (× 1.5) and **Q 3** (× 2.0).

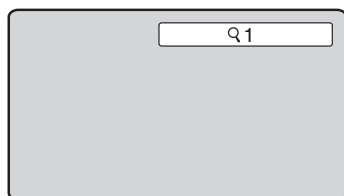

- 2 Press **▲▼◀▶** to pan the scene and view different sections of the picture.
- 3 To return to normal view, in Zoom mode, press **ZOOM** repeatedly until **Q Off** appears.

Note:

- You can use the Pause, Slow and Search playback functions in Zoom mode.
- Zoom function may not apply to some discs.

Locating a specific scene

[DVD]

- 1 Press **JUMP** during playback, still or stop mode.

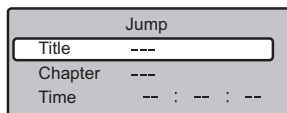

- 2 Press **▲** or **▼** to select a navigation option.

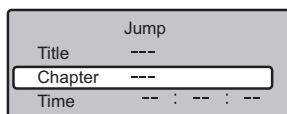

- 3 Use the Channel Number buttons (0-9) to key in a value for the navigation option you selected.

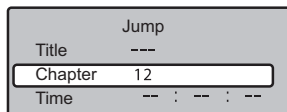

If you input a wrong number, press **CANCEL** **ENT**. Refer to the disc package to check the correct number.

- 4 Press **PLAY** or **OK** to start playback.

[VCD/CD]

For audio CDs and Video CDs, you can locate a scene by track number or record time.

VCD mode

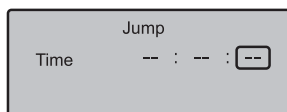

CD mode



Note:

- When you use title navigation, playback starts from the first chapter of the selected title.
- For PBC-enabled VCDs, turn off the PBC function first before using the Jump function (see page 61).
- Scene navigation may not apply to some discs.

Scene bookmark



Scene bookmarks refer to specific points in the playback range that have been marked for later access. You can create up to three markers per disc.

Note: *The saved scene bookmarks are only accessible during the current session. Once you eject the disc or turn off the LCD TV / DVD combination, all bookmarks will be cleared.*

Bookmarking a scene (DVD/VCD/CD)

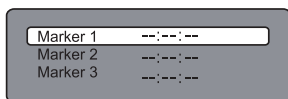
- 1 During playback, press  at the scene where you would like to place the bookmark.



- 2 Press  or  to select a blank marker, then press  to bookmark the selected scene.

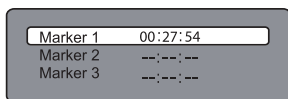



- 3 Press  to close the bookmark window.
- 4 To save two more bookmarks, repeat steps 1-3.

Note:

- In some cases, subtitles for the marked scene may not display.
- Bookmarking a scene may not apply to some discs.

Viewing a scene bookmark (DVD/VCD/CD)

- 1 Press  during playback mode.
- 2 Press  or  to select the saved marker.

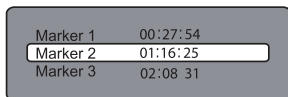

- 3 Press  to start playback on the scene saved in the selected bookmark.

To delete a scene bookmark:

Perform steps 1 and 2 above, then press .

Repeat playback/A-B repeat

You can choose to repeat DVD playback by title or chapter. For audio CDs and Video CDs, you can repeat a single track or the entire disc.

The A-B repeat function lets you repeat a specific section between two set points. This section will be played repeatedly until you turn off the A-B repeat mode.

Enabling repeat playback (DVD/VCD)



- 1 Press  during playback or stop mode.

- 2 [DVD]
Press  repeatedly to select a repeat mode. It can either be by **Chapter** or by **Title**.

The LCD TV / DVD combination automatically starts repeat playback after finishing the current title or chapter.



[VCD]

- Press  to select **Repeat**, then press  repeatedly to select a repeat mode. It can either be **Single** or **All**.

The LCD TV / DVD combination automatically starts repeat playback after finishing the current track.





Note: *If you set the repeat mode during stop mode, press  to start Repeat playback.*

- 3 Press  again to close the Play Mode window.

To resume normal playback:

Select **Off** in step 2 above.

Note:

- The Repeat mode is canceled when  or  is pressed.
- The Repeat playback function may not apply to some discs.

(continued)

Enabling A-B repeat mode (DVD/VCD/CD)

- 1 During playback, press  at the point where you would like the playback loop to begin. This sets your "A" point.



- 2 When the playback reaches the point where you would like the playback loop to stop, press  again. This sets your "B" point.

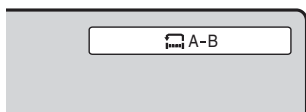

The section between points A and B will be played repeatedly in a loop until you turn off the Repeat A-B mode.

To resume normal playback:

Press  until  Off appears on-screen.

Note:

- In some cases, subtitles for the repeated scene may not display.
- The A-B repeat mode may not apply to some DVD scenes.
- The A-B repeat mode is not applicable to interactive DVDs and JPEG CDs.

Programmed playback/Random playback





You can program the playback sequence of tracks on a Video CD. Or you can set the LCD TV / DVD combination to play tracks at random.

For procedures applicable to audio CD / MP3 / WMA / JPEG, go to page 62.





Note:

- The programmed and random playback modes are not applicable to PBC-enabled Video CDs.
- The programmed and random playback modes are only applicable during the current session. Once you eject the disc or turn off the LCD TV / DVD combination, these modes will be disabled.

Programming the playback sequence (VCD)





- 1 Press  in stop mode.
- 2 Press  or  to select **Mode**, then press . Repeatedly to select **Program**.

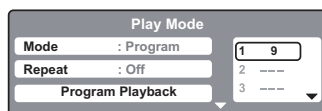

- 3 Press  or  to go to the right column. Press  or  to select the playback position, then use the Channel Number buttons (0-9) to input the track for that position.

To program other tracks, repeat this step. If you input a wrong number, press .



- 4 Press  or  to return to the left column, then press  or  to select **Program Playback** and press .



Track playback will follow the sequence you set in step 3.

(continued)

To resume normal playback:

In step 2, set **Mode** to **Normal**.

To change the program:

1. Set **Mode** to **Program**.
2. Press ◀ or ▶, then ▲ or ▼ to select the playback position you want to change the track input for, then press .
3. Use the Channel Number buttons (0-9) to input the new track for the selected position.



To remove a track from the programmed list:

1. Set **Mode** to **Program**.
2. Press ◀ or ▶, then ▲ or ▼ to select the playback position, then press .

To clear all the programs:

On the left column, press ▲ or ▼ to select **Clear Program**, then press .

Enabling random playback (VCD)

- 1 Press  in stop mode.
- 2 Press ▲ or ▼ to select **Mode**, then press  repeatedly to select **Shuffle**.



- 3 Press  to start random playback.

Note: If you set random playback during playback mode, random playback will begin after the current track finished playing.



To resume normal playback:

In step 2, set **Mode** to **Normal**.

Scene angle/Title selection/DVD menu

Changing the scene angle (DVD)



When playing back a DVD recorded with multiangle scenes, you can select the scene angle that you prefer.

- 1 Press  during playback.
- 2 Press  repeatedly until the preferred scene angle is displayed.

Note: Depending on the DVD, you may not be able to change the scene angle even if multiangle data are recorded on the disc.

Selecting a DVD title (DVD)

Some DVDs contain two or more titles. If this is the case, you can select a particular title for playback.





- 1 Press  during playback to display the title menu.
- 2 Press ▲▼◀▶ to select the preferred title.
- 3 Press  or  to start playback.

Note:

- Title selection may not apply to some DVDs.
- The title menu may simply be referred to a "menu" or "title" in the instructions supplied with the DVD.

DVD menu (DVD)

Some DVDs have an encoded menu that allows users to select a specific disc content, enable a particular DVD feature (e.g. subtitle or soundtrack language), or choose a particular title (for multitrack DVDs).

- 1 Press  during playback.
- 2 Press ▲▼◀▶ to select a DVD menu item, then press  or  to access it. Use the same keys to enable an option for the selected item. Repeat this step to configure other menu options.
- 3 Press  again to resume playback on the scene that was playing when you pressed .

Note: Depending on the DVD, you may not be able to resume playback from the same scene that was playing when you pressed .

Soundtrack language/Audio channel/Subtitle

Selecting a soundtrack language (DVD)

You can select the soundtrack language when you play a multilingual DVD.

During playback, press  repeatedly until the preferred language track is selected.

Selecting the audio channel (VCD)

During playback, press  repeatedly until the preferred audio channel is heard. Options include **Stereo**, **Left**, **Right**, and **Mix**.

Note:

- If the preferred language option is not heard after selecting it for several times, that language is not recorded on the disc.
- The soundtrack language selected is only applicable for the current session. When you stop playback and try to play the disc again, the default language track will be used.

Viewing subtitles (DVD)

When playing back a disc recorded with subtitles, you can select the subtitle language or turn the subtitle off.

To view subtitles:

Press  repeatedly during playback until the preferred language is selected. The Subtitle prompt will disappear after a few seconds.

To disable subtitles:

Press  until **Off** appears.

Note:

- Not all DVDs have encoded subtitles.
- The subtitle selection may revert to the default language when you stop playback and try to play the DVD again.
- In some cases, the selected subtitle may not display immediately.

Playback information/VCD playback control

Viewing the playback info (DVD/VCD)

Press  during playback. DVD mode

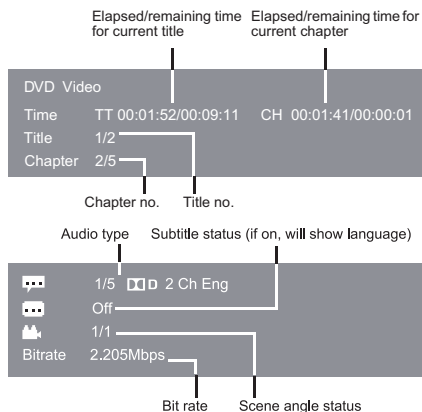

VCD mode

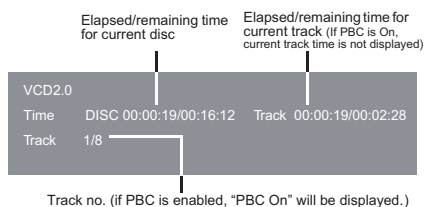





To close the information display:

Press .

Note: Depending on the disc, this operation may not be available.

Turning off the PBC function (VCD)

- 1 Press  in stop mode.
- 2 Press  or  to select **Mode**, then press  repeatedly until **Normal** appears.



- 3 Press  to close the screen.

To turn on the PBC function:

Follow steps 1 and 2 above, then press  repeatedly until **PBC** appears.

When enabled, PBC allows interactive Video CD playback using the remote control.

MP3, WMA, JPEG, and Audio CD operation

This LCD TV / DVD combination can play MP3, WMA, and JPEG files recorded on a CD-R or CD-RW disc. To create the MP3/WMA/JPEG disc, you need a Windows PC with a CD-RW drive and file encoding software. You must use a Windows PC to create the MP3/WMA/JPEG disc.

This LCD TV / DVD combination requires discs/recordings that meet certain technical standards in order to achieve optimal playback quality. There are many different types of recordable disc formats (including CD-R discs containing MP3 or WMA files). Not all recordable discs will produce optimal playback quality. The technical criteria set forth in this owner's manual are meant only as a guide. Use of CD-RW discs for recording MP3 files is not recommended.

You must obtain any required permission from copyright owners to download or use copyrighted content. *Toshiba can not and does not grant such permission.*

MP3/WMA/JPEG/Audio CD information (CD)

MP3/WMA/JPEG CD playback reminders

- Make sure the file name of the MP3, WMA, and JPEG files in the CD includes the 3-character file extension ("mp3", "wma", "jpg", "div", and "avi") to make it compliant with the ISO 9660 standard.
- This LCD TV / DVD combination can read 2000 files per disc. If a disc has more than 2000 files, it reads the first 2000 files, while the remaining files will be omitted.
- To play the files in sequence based on the recorded order:
 - Use an encoding software that records data alphabetically or numerically.
 - Include a two- or three-digit number prefix on the file name (ex. "01" "02" or "001" "002").
 - Refrain from making too many sub-folders.
- It may take more than one minute for this LCD TV / DVD combination to read MP3, WMA, and JPEG files depending on the disc structure.
- Audio files recorded using the Joliet Recording Specification can be played back in this LCD TV / DVD combination. The file name is displayed (up to 15 characters). Longer file names will be condensed.
- Music recorded based on the Joliet Recording Specification can be played back, the file name is displayed (within 15 letters) on the screen. Long file names will be condensed.
- This LCD TV / DVD combination does not support data disc burned using the Apple Mac OS (Hierarchical File System, HFS format).
- MP3/WMA/JPEG CDs cannot be used for recording purpose.

File name display reminders

- The maximum number of characters for file name display is 15.
- Only the following characters will be displayed: A through Z (both upper and lower case), 0 through 9, and the underscore symbol (_).
- Non-supported characters will be replaced with a hyphen (-).

MP3/WMA/JPEG CD limitations

- Depending on the recording conditions, some MP3/WMA/JPEG CDs cannot be played back in your LCD TV / DVD combination.
- Only MP3, WMA, and JPEG files recorded in the CD-R/RW disc will be played. Other files will not be read nor displayed.

MP3/WMA file encoding information

- MP3
 - File format: MPEG-1 Audio
 - Sampling frequency: 32 kHz, 44.1 kHz, 48 kHz
 - Bit rate: 32 to 320 kbps (constant bit rate or variable bit rate)The recommended recording setting for high-quality sound is 44.1 kHz sampling frequency and 128 kbps constant bit rate.
- WMA
 - File format: WMA version 7 or 8
 - Sampling frequency: 32 kHz / 48 kbps, 44.1 kHz / 48 to 92 kbps, 48 kHz / 128 to 192 kbpsA file recorded in mono (48 kHz / 48 kbps) is not supported by this LCD TV / DVD combination.

Microsoft, Windows Media, and Windows Logo are either registered trademarks or trademarks of Microsoft Corporation in the United States and/or other countries.

MPEG Layer-3 audio coding technology licensed from Fraunhofer IIS and Thomson.

About the file browser (CD)

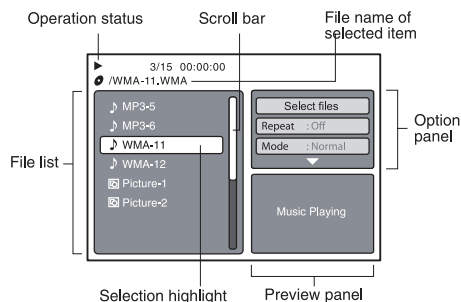

File icons

- Music file (MP3/WMA/Audio CD track)
- Picture file (JPEG)

If a CD contains a mixture of MP3, WMA and JPEG files, and **PLAY** is pressed without selecting a file, playback automatically begins starting from the first file in the list.

Setting the file type listing

You can choose the type of files listed in the file browser.

- 1 Press **▶** to move the selection highlight to the Option panel.
- 2 Press **▲** or **▼** to highlight **Select files**, then press **OK**.
- 3 Press **▲** or **▼** to select a file type from the list — **Audio** or **Photo**.
- 4 Press **OK** to add or remove the check mark next to each file type. Checked file type will be displayed in the file browser.
- 5 Press **◀** twice to move the selection highlight back to the file list.

Viewing image files in thumbnail mode

You can change the browser's view mode from list mode to thumbnail mode. This is convenient when browsing for JPEG files.

- 1 Press **DVD MENU**.
- 2 Press **▲▼◀▶** to select an image file.
- 3 Press **OK** to play an image file you want.

To return the browser to list mode:

Press **TOP MENU**.

To view the previous or next thumbnail page:

Press **SKIP** **◀** or **SKIP** **▶**.

Playing an audio file (CD)

- 1 Load an MP3/WMA/Audio CD in the disc slot. The file browser appears on-screen. It may automatically play by composition of an audio file.

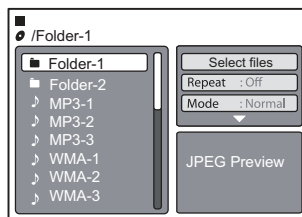

- 2 Press **▲** or **▼** to select another audio file for playback.

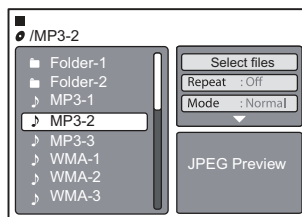

- 3 Press **PLAY** or **OK** to start playback.

To stop playback:

Press **STOP**.

The LCD TV / DVD combination records the stop point. **⏏** appears on-screen. Press **PLAY** to resume playback. If you press **STOP** twice in quick succession or unload the disc, the LCD TV / DVD combination will clear the stop point.

Note:

- If the current directory has more than eight files, press **▲** or **▼** to scroll the file list.
- To see folder contents, select a folder and then press **OK**.
- To return to the root directory, press **RETURN** or select **"Go Up..."** then press **OK**.
- In thumbnail mode, press **PIC SIZE** repeatedly to change the thumbnail size.
- The Repeat and Random/Programmed playback modes can be enabled during MP3 or WMA playback. Refer to page 65, (continued)

Viewing a JPEG file (CD)

- 1 Load a disc containing JPEG files in the disc slot. The file browser appears on-screen.
- 2 Press **▲** or **▼** to select an image file for view. A preview of the selected file is displayed in the Preview panel.

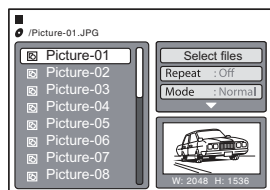

- 3 Press **OK** or **PLAY**. The selected image is displayed in full-screen mode.



Press **SKIP** (◀) or **SKIP** (▶) to view the previous or next image file in the current directory.

To rotate an image:

Press **ANGLE** (◻) repeatedly until the preferred angle is obtained. The image angle is adjusted in 90° increments. The current angle setting is shown on-screen: **90°**, **180°**, **270°** or **No rotation**.

To magnify an image:

Press **ZOOM** (◻) repeatedly until the image is displayed in the preferred scale. The current zoom setting is indicated by the following icons: **Q 1** (× 1.3), **Q 2** (× 1.5) and **Q 3** (× 2.0).

To return to normal view:

Press **ZOOM** (◻) repeatedly until **Q Off** appears.

Viewing a slide show (CD)

If there are multiple JPEG files in the selected directory, you can view them in a slide show. For instructions on how to enable the slide show feature and set the interval period between pictures, go to page 69.

- 1 Open the file folder containing the JPEG files you want to include in the slide show.
- 2 Press **▲** or **▼** to select the file you want to be the starting image for the slide show. A preview of the selected file is displayed in the Preview panel.

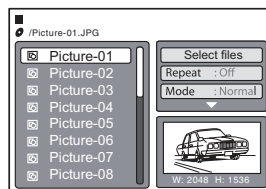

- 3 Press **OK** or **PLAY**. The selected image is displayed in full-screen mode. When the slide show is completed, the file browser appears.

To view the previous or next image in the slide show:

Press **SKIP** (◀) or **SKIP** (▶).

To temporarily stop the slide show:

Press **PAUSE** (⏸). "⏸" appears briefly on-screen. Press **PLAY** (▶) to resume the slide show.

To stop the slide show:

Press **STOP** (■). The file browser appears.

Note:

- The Rotate and Zoom modes are available in regular JPEG viewing and slide show modes.
- The Jump and A-B repeat modes are not available when viewing JPEG images.
- During a slide show, the interval time between images may increase if the file size is too big.
- When an image exceeds 5760 x 3840 pixels, the image display can appear cropped. This applies when viewing the image in the Preview panel of the file browser; or when in the thumbnail, fullscreen or slide show modes.

MP3, WMA, JPEG and Audio CD playback modes

You can choose to repeat CD playback by track or the entire disc. You can also program the file playback sequence or set the LCD TV / DVD combination to play files at random.

Note: These playback modes are only applicable during the current session. Once you eject the disc or turn off the LCD TV / DVD combination, these modes will be disabled. Pressing **SKIP** (⏮) or **SKIP** (⏭) during playback will also cancel these modes.

Enabling repeat playback (CD)

- 1 During stop mode, in the Option panel of the file browser, press **▲** or **▼** to select **Repeat**.



- 2 Press **OK** repeatedly to select a repeat mode, **Track** or **All**.

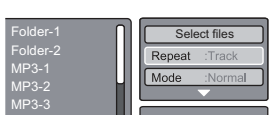

- 3 Press **PLAY** (▶). The LCD TV / DVD combination automatically starts repeat playback after finishing the current track.

To resume normal playback:

Select **Off** in step 2 above.

Enabling random playback (CD)

- 1 During stop mode, in the Option panel of the file browser, press **▲** or **▼** to select **Mode**.

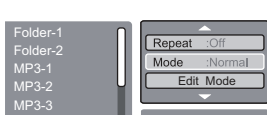

- 2 Press **OK** repeatedly to set mode to **Shuffle**.

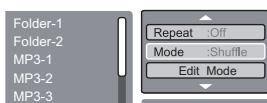

- 3 Press **PLAY** (▶). The LCD TV / DVD combination automatically applies the shuffle mode.

To resume normal playback:

Select **Normal** in step 2 above.

To activate Music Intro mode:

Select **Music Intro** in step 2 above.

Press **PLAY** (▶).

Note: When the **Music Intro** mode is enabled, the first 10 seconds of an audio track is played. This is useful if you are simply looking for a particular track in a list.

(continued)

Programming the playback sequence (CD)

- 1 In the Option panel of the file browser, press ▲ or ▼ to select **Edit Mode**, then press **OK**.



- 2 Press ◀ to return to the file list and press ▲ or ▼ to select a file, then press **OK** to mark it for inclusion in the programmed playlist. A check mark will appear next to the file.

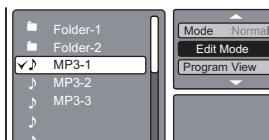

Repeat this step to mark any other files you want to add in the programmed playlist.

- 3 In the Option panel, press ▲ or ▼ to select **Add To Program**, then press **OK** to add the marked files in the programmed playlist.



- 4 Press ▲ or ▼ to select **Edit Mode**, then press **OK** to disable it.



- 5 Press ▲ or ▼ to select **Program View**, then press **OK**.

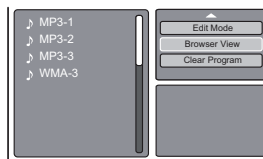

Program View

In Program view, only the files you added in step 3 are displayed.



Browser View

- 6 In the programmed file list, press ▲ or ▼ to select a file, then press **PLAY** to start playback.

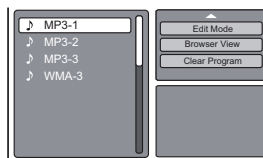

To remove a file from the programmed list:

1. Press **STOP** twice to stop playback.
2. In Program view, press ▲▼◀▶ to select **Edit Mode** on the Option panel, then press **OK** to enable it.
3. Press ◀ to go to the programmed list.
4. Press ▲ or ▼ to select the file you want to remove, then press **OK**.
5. Repeat step 4 to mark any other files you want to remove from the list.
6. Press ▶ to go to the Option panel.
7. Press ▲ or ▼ to select **Clear Program**, then press **OK**.

Customizing disc playback

You can customize the disc playback settings to suit your preferences.

Configuring the disc playback settings (DVD/VCD/CD)

- 1 In DVD mode, press **SETUP** during stop mode.

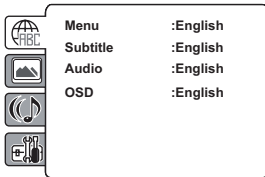

- 2 Press **▲** or **▼** to select a setup tab, then press **▶**. The first setup option is highlighted.

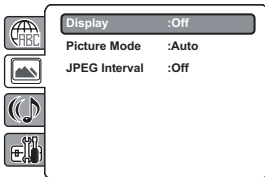





- 3 Press **▲** or **▼** to select the setup option you want to customize.
- 4 Press **▶** or **OK** to display a list of available option settings.
- 5 Press **▲** or **▼** to select an option setting, then press **OK** to apply and save it.
Go to pages 68-71 for list of description for each option setting.
- 6 To configure another option on the same setup tab, repeat steps 3-5.
To configure an option on another tab, press **◀**, then use **▲** or **▼** to select a setup tab.
Repeat steps 3-5 to configure the preferred option.

- 7 To close the Setup screen, press **SETUP** or **RETURN**.

(continued)

Disc playback setup

Tab	Option	Description	Go to page
	Menu	Select the language for the DVD menu display.	69
	Subtitle	Select the subtitle language for disc playback.	
	Audio	Select the audio language for disc playback.	
	OSD	Select the language for the Setup screen display.	
	Display	Choose whether to show a status display whenever a button is pressed.	69
	Picture Mode	Select the DVD source content.	
	JPEG Interval	Select the interval time between images in a slide show.	
	Night Mode	Toggle the night mode on or off.	70
	Digital Out	Select the format for the digital audio output corresponding to your audio connection.	
	Parental	Set the restriction level for allowable disc content.	70
	Password	Change the access password for the parental control setting.	71

Note: These setup settings are retained in the LCD TV / DVD combination's memory. It remains active even if the power is turned off.

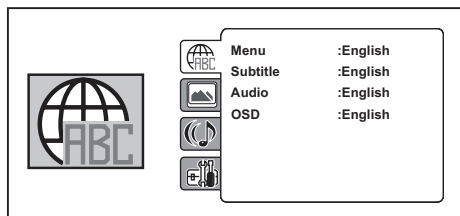

■ Menu / ■ OSD

Select the language for the DVD and Setup menu display. Options include: English, French, and Spanish.

■ Subtitle / ■ Audio

Select the language for the subtitle display and audio track output during disc playback.

English The selected language will be heard or seen.

French

Spanish

Auto (Subtitle) The LCD TV / DVD combination will display the subtitle in the disc's default language.

Off (Subtitle) There will be no subtitle display.

Note: If the selected language is not available, the default disc language will be used.

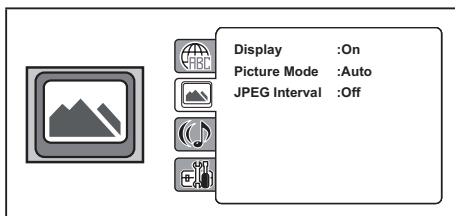

■ Display

Choose whether to show a status display whenever a button is pressed.

Off There will be no on-screen display.

On There will be on-screen display when any button is pressed.

■ Picture Mode

The source content of a DVD can either be recorded in: film format (images are recorded at 24 frames per second) or video format (images are recorded at 30 frames per second).

Auto The LCD TV / DVD combination automatically detects the type of source content and converts that signal in an appropriate method based on the current aspect ratio of the LCD TV / DVD combination. This option will normally suit most DVDs.

Film Suitable for playback of DVDs recorded in a film format.

Video Suitable for playback of DVDs recorded in a video format.

Note: If picture appears cut off or doubled, select the "Video" setting.

■ JPEG Interval

Select the interval time between images during a JPEG slide show.

Off Slide show option is disabled.

5, 10, or 15 seconds Images will be displayed in a slide show using the selected interval time.

(continued)

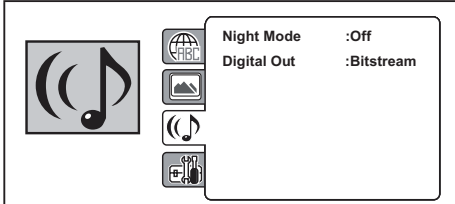

■ Night Mode

Select to toggle the Night Mode feature on or off. When enabled, this function allows for automatic volume level adjustment for audio that may be too low (e.g. whispered dialogues) or too high (e.g. a thunderstorm scene).

- Off** Audio retains its disc recording volume level.
- On** Volume level is automatically adjusted depending on the scene content.

***Note:** The Night Mode feature is only applicable to Dolby Digital-featured DVDs. The adjusted sound level depends on the DVD encoding.*

■ Digital Out

Select the sound format of the digital output depending on the enabled signal connection.

- Off** Disables digital sound output. Select this option when there's no equipment connected to the optical DIGITAL AUDIO OUT jack.
- PCM** Changes Dolby Digital output to PCM. Select this option when using a two-channel digital stereo amplifier.
- Bitstream** Select this option to output the signal in its native format.

***Note:** MPEG audio will always be in PCM format regardless of the Digital Output setting.*

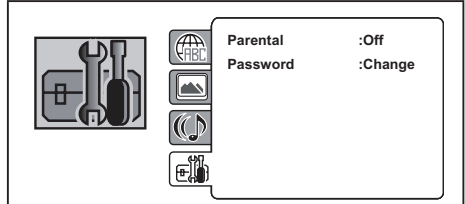

■ Parental

A DVD is usually encoded with a rating level to indicate the recommended audience age. You have the option to select the content rating level allowed for playback in your LCD TV / DVD combination.

You will be prompted to key in the system password to access this settings option.

Press **▲** or **▼** to select the allowable rating level, then press **OK**.

- Off** No playback restriction. All discs can be played regardless of content rating.
- Level 1–5** Discs of varied non-adult ratings will be played back. The higher the number, the more severe the content is.
- Level 6–8** Discs of varied adult only ratings will be played back.

Note:

- The Parental rating levels correspond to the US movie ratings.

Level 1 – Kids Safe	Level 5 – PG–R
Level 2 – G	Level 6 – R
Level 3 – PG	Level 7 – NC–17
Level 4 – PG–13	Level 8 – Adult

- Some discs may not have their rating level encoded on the disc though it's indicated on the disc jacket. Playback restriction will not apply to these discs so make sure to restrict access to it manually.

(continued)

To temporarily cancel the parental restriction:

- 1) Load the restricted content DVD that you want to play.
- 2) Use the Channel Number buttons (0–9) to input the system password after the “Enter Password” message, then press **OK**.

This suspension of the parental restriction setting applies until disc is ejected.

■ Password

Select this option to change the access password for the parental control setting.

- 1) Press **▲** or **▼** to select **Password**, then press **OK**.
- 2) Use the **Channel Number buttons (0–9)** to input the current password, then press **OK**.
If the password has not been set yet, key in “0000”. This is the factory default password.
- 3) Use the **Channel Number buttons (0–9)** to input the new password, then press **OK**.
You will be prompted to confirm the new password.
- 4) Use the **Channel Number buttons (0–9)** to input the new password again, then press **OK**.
- 5) Press **OK** one last time to confirm the changed password. Note this new password for future reference.

If you forget the system password:

- 1) Make sure there is no disc in the disc slot.
- 2) Press and hold down “4” on the remote control, then press **VOLUME-** on the TV control panel.

The “Initializing” message appears on-screen to indicate that the password has been reset to its default factory setting “0000”. All DVD Setup related settings will also be reset to their default factory values.

General troubleshooting

Before calling a service technician, please check this chapter for a possible cause of the problem and some solutions you can try.

Black box on-screen

- The closed caption feature is set to one of the Text modes (T1, T2, T3, or T4). Set the closed caption feature to Off (☞ page 38).

TV stops responding to controls

- If the TV stops responding to the controls on the remote control or TV control panel and you cannot turn off the TV, press and hold **POWER** on the TV control panel for 5 or more seconds to reset the TV.
- If you cause a static discharge when touching the TV and the TV fails to function, simply unplug the TV from the AC outlet and plug it back in. The TV should return to normal operation.

Other problems

- If your TV's problem is not addressed in this Troubleshooting section or the recommended solution has not worked, use the Reset Factory Defaults procedure (☞ page 29).

TV will not turn on

- Make sure the power cord is plugged in, and then press **POWER**.
- The remote control batteries may be dead. Replace the batteries or try the control panel buttons.

Picture problems

General picture problems

- Check the antenna/cable connections (☞ Chapter 2).
- Press **INPUT** on the remote control or TV and select a valid video input source (☞ page 30). If no device is connected to a particular input on the TV, no picture will display when you select that particular input source. For device connection details, see Chapter 2.
- Antenna reception may be poor. Use a highly directional outdoor antenna (if applicable).
- The station may have broadcast difficulties. Try another channel.
- Adjust the picture qualities (☞ page 38).

Video Input Selection problems

- If the **Input Selection** window does not appear when you press **INPUT** on the remote control or TV, press **INPUT** a second time, which will change to the next video input source and display the **Input Selection** window.

Cannot view external signals or channel 3 or 4

- If you cannot view signals from external devices connected to **VIDEO**, **ColorStream® HD**, **HDMI 1**, **HDMI 2**, **PC** or from channels 3 or 4, make sure the **Input Lock** is set to **Off** (☞ page 44).

Noisy picture

- If you are watching an analog channel (off-air broadcast or Cable TV), you can set the **CableClear®** feature to reduce visible interference in the TV picture (☞ page 54).

Poor color or no color

- The station may have broadcast difficulties. Try another channel.
- Adjust the **Tint** and/or **Color** (☞ page 38).

Poor composite picture

- If the TV is connected to an external A/V device (e.g., DVD player, video game system, set-top box, etc.) try using a **ColorStream** or **HDMI** video connection instead.

Picture and sound are out of sync

- As with all products that contain a digital display, in rare instances, when viewing certain content (e.g. television broadcasts, video games, DVDs), you may notice that the sound and picture are slightly out of sync. This phenomenon can be caused by various factors including, without limitation, video processing within the TV, video processing in an attached gaming system, and video processing or different compression rates used by broadcasters in their programming. You may want to try one or more of the following suggestions, which may help to reduce the effect of this phenomenon:
 - If the TV is connected to an A/V receiver that has a programmable audio delay feature, use this feature to help synchronize the sound to the picture.
 - If you notice this phenomenon only on certain TV channels, please contact your local broadcast, cable, or satellite provider to inform them of this issue.

Sound problems

- Check the antenna/cable connections (☞ Chapter 2).
- The station may have broadcast difficulties. Try another channel.
- The sound may be muted. Press **VOLUME**.
- If you hear no sound, try setting the **MTS** feature to **Stereo** mode (☞ page 40).
- If you are not receiving a second audio program from a known SAP source, make sure the **MTS** feature is set to **SAP** mode (☞ page 40).
- If you hear audio that seems “incorrect” for the program you are watching (such as music or a foreign language), the SAP mode may be on. Set the **MTS** feature to **Stereo** mode (☞ page 40).

Remote control problems

- Remove all obstructions between the remote control and the TV.
- The remote control batteries may be dead. Replace the batteries (☞ page 21).
- If the TV still does not act as expected, use the Reset Factory Defaults procedure (☞ page 29).

Channel tuning problems

- The channel may be locked by the **Channel Options** feature. Unlocked the channel (☞ page 44).
- If you are unable to tune digital channels, check the antenna configuration (☞ page 26). If you are still unable to tune digital channels, use the Reset Factory Defaults procedure (☞ page 29). Also see “TV stops responding to controls” and “Other problems” (☞ page 72).

Closed caption problems

- If the program or video you selected is not closed captioned, no captions will display (☞ page 38).
- If text is not available, a black rectangle may appear. If this happens, turn off the closed caption feature (☞ page 38).
- A closed-caption signal may not display correctly in the following situations: a) when a videotape has been dubbed; b) when the signal reception is weak; or c) when the signal reception is non-standard (☞ page 38).

Rating blocking (V-Chip) problems

- If you forget your PIN code: While the PIN code entering screen is displayed, press  four times within 5 seconds. The PIN code you previously stored will be cleared (☞ page 41).
- The V-Chip feature is available for the U.S. and Canada V-Chip systems (☞ page 41).

No REGZA-LINK® operation

- The REGZA-LINK® feature is available for Toshiba REGZA-LINK® compatible devices.
- Make sure the HDMI cables with the HDMI Logo () are used.
- When the connected REGZA-LINK® device does not work correctly after you have changed settings of the device, turn off your TV and unplug the power cord, then plug and turn on again.
- If several devices are connected, REGZA-LINK® feature may not operate properly.
- Read the instruction manual furnished with the connected REGZA-LINK® device.

HDMI problems

For HDMI cables

- Make sure to use cables with the HDMI Logo () (☞ page 14).

For Legacy HDMI source

- Some legacy HDMI sources may not work properly with the latest HDMI TV products, due to new standard adoption.

Media Player problems

- Make sure that devices are connected correctly.
- Incorrect behavior may occur with a USB HUB connection.
- Photo files that was processed and edited by using the PC's application software may not be able to be viewed.
- The TV may select one format automatically and play it when contents that support two or more formats are played.
- Confirm contents of the USB storage device are formats that correspond with this TV (☞ page 46).

Disc playback problems

Playback does not start

- No disc is loaded.

- The disc may be dirty. Clean the disc.
- The disc format is not supported (☞ page 8).

No picture

- The TV is not in DVD mode.

No sound

- The TV is in the special playback mode (☞ page 56).
- If an external speaker is connected, check its volume control.

Picture distortion during fast reverse/forward playback

- The picture will be distorted occasionally. This is normal.

Playback features failure

- The playback features such as stopping, searching, slow motion play, repeat play or programmed play, etc are not applicable to all discs.

Playback does not start when the title is selected

- The disc may not be compliant with the "Parental" setting (☞ page 70).

The audio soundtrack and/or subtitle language cannot be changed

- The disc has no multilanguage option encoded on it (☞ page 61).

No subtitle

- The disc has no subtitle encoded on it.

- Subtitles are disabled. Press  (☞ page 61).

Scene angle cannot be changed

- The disc has no multiangle scenes (☞ page 60).

"X" appears on the screen

- The function is not applicable to the disc or to the current mode (☞ page 7).

LED Indication

The Power LED light on the TV front indicates the TV's status, as described below.

LED Indication

Power LED

- **Green is ON (solid)**

The TV is operating properly.

- **Red is ON (solid)**

The TV is in Standby mode.

If, after trying the solutions, the problem still exists:

• In the U.S., visit TAIS's Consumer Solution Center on the web at <http://support.toshiba.com> or call 1-800-631-3811

• In Canada, locate the nearest Toshiba authorized service depot by directing your web browser to www.toshiba.ca/support

Specifications

Note:

- *These models comply with the specifications listed below.*
- *Designs and specifications are subject to change without notice.*
- *These models may not be compatible with features and/or specifications that may be added in the future.*

Television System

NTSC standard
ATSC standard (8VSB)
Digital Cable (64 QAM, 256 QAM; in-the-clear, unencrypted)

Channel Coverage

VHF: 2 through 13
UHF: 14 through 69
Cable TV:
Mid band (A-8 through A-1, A through I)
Super band (J through W)
Hyper band (AA through ZZ, AAA, BBB)
Ultra band (65 through 94, 100 through 135)

Power Source: 120 V AC, 60 Hz

Power Maximum Current

19SLV411U: 0.55 A
24SLV411U: 0.75 A
32SLV411U: 1.35 A

Power Consumption

19SLV411U: 0.5 W in standby mode
24SLV411U: 0.5 W in standby mode
32SLV411U: 0.5 W in standby mode

Audio Power:

19SLV411U: 3 W + 3 W
24SLV411U: 5 W + 5 W
32SLV411U: 7 W + 7 W

Speaker Type:

19SLV411U: Two 3-5/8 x 1 x 5/8 inches
(91 x 25 x 15mm)
24SLV411U: Two 3-5/8 x 1 x 7/8 inches
(91 x 25 x 23mm)
32SLV411U: Two 5-5/8 x 1 x 5/8 inches
(142 x 25 x 16mm)

Video/Audio Terminals

VIDEO/AUDIO INPUT:

VIDEO: 1 V(p-p), 75 ohm, negative sync.
AUDIO: 200 mV(rms) (-20dBFS, 47K ohm or greater)

ColorStream® (component video) HD INPUT:

VIDEO: Y: 1V(p-p), 75 ohm, negative sync.
Pr: 0.7 V(p-p), 75 ohm
Pb: 0.7 V(p-p), 75 ohm
Suggested formats: 1080i, 720p,
480p, 480i

AUDIO: 200 mV(rms) (-20dBFS, 47K ohm or greater)

HDMI® INPUT:

HDMI compliant
HDCP compliant
HDMI Audio: 2-channel Linear-PCM; 32/44.1/
48 kHz sampling frequency; 16/
20/24 bits per sample

DIGITAL AUDIO OUTPUT: Optical type

PC INPUT: 15-Pin D-sub Analog RGB

DVD/CD player

Signal system: NTSC
Supported disc size: 12 cm, 8 cm
Pickup mechanism: 1-lens, 2-beams

Dimensions

19SLV411U:
Width: 1'6-1/2 inches (470.1 mm)
Height: 1'1-1/2 inches (343.3 mm)
Depth: 7-5/8 inches (194.0 mm)
24SLV411U:
Width: 1'11 inches (583.1 mm)
Height: 1'4-1/8 inches (410.9 mm)
Depth: 9-1/8 inches (233.2 mm)
32SLV411U:
Width: 2'6-1/2 inches (775.4 mm)
Height: 1'8-1/8 inches (512.5 mm)
Depth: 7-7/8 inches (200.0 mm)

Mass (Weight)

19SLV411U: 9.9 lbs (4.5 kg)
24SLV411U: 13.2 lbs (6.0 kg)
32SLV411U: 19.8 lbs (9.0 kg)

Operating conditions

Temperature: 32°F - 95°F (0°C - 35°C)
Humidity: 20 - 80% (no moisture condensation)

Supplied Accessories

- Remote control with two size "AAA" batteries
- Owner's manual (this book)
- Four screws for holding the pedestal stand
- Instruction manual

Acceptable signal formats for PC IN and HDMI terminals

PC IN signal formats

Note: Depending on the connected PC, the following status may occur; incorrect display, false format detection, picture position failure, blur, or judder. But this is not a malfunction of your TV.

Format	Resolution	V. Frequency	H. Frequency	Pixel Clock Frequency
VGA	640 × 480	59.940Hz	31.469kHz	25.175MHz
SVGA	800 × 600	60.317Hz	37.879kHz	40.000MHz
XGA	1024 × 768	60.004Hz	48.363kHz	65.000MHz
WXGA	1280 × 768	59.870Hz	47.776kHz	79.500MHz
	1360 × 768	60.015Hz	47.712kHz	85.500MHz
SXGA	1280 × 1024	60.020Hz	63.981kHz	108.000MHz (24SLV411U)

HDMI signal formats

Format	Resolution	V. Frequency	H. Frequency	Pixel Clock Frequency
VGA	640 × 480	59.940Hz	31.469kHz	25.175MHz
SVGA	800 × 600	60.317Hz	37.879kHz	40.000MHz
XGA	1024 × 768	60.004Hz	48.363kHz	65.000MHz
WXGA	1280 × 768	59.870Hz	47.776kHz	79.500MHz
	1360 × 768	60.015Hz	47.712kHz	85.500MHz
SXGA	1280 × 1024	60.020Hz	63.981kHz	108.000MHz
480i	720 × 480i	59.940Hz	15.734kHz	27.000MHz
480p	720 × 480p	59.940Hz	31.469kHz	27.000MHz
720p	1280 × 720p	60.000Hz	45.000kHz	74.250MHz
1080i	1920 × 1080i	60.000Hz	33.750kHz	74.250MHz
1080p	1920 × 1080p	24.000Hz	27.000kHz	74.250MHz
1080p	1920 × 1080p	60.000Hz	67.500kHz	148.500MHz

- Some illustrations in this owner's manual are for explanation purposes and may differ from the actual unit.
- Designs and specifications are subject to change without notice.
- These models may not be compatible with features and/or specifications that may be added in the future.

Limited United States Warranty for LCD TV/DVD Combination

Toshiba America Information Systems, Inc. ("TAIS") makes the following limited warranties to original consumers in the United States.

THESE LIMITED WARRANTIES EXTEND TO THE ORIGINAL CONSUMER PURCHASER OR ANY PERSON RECEIVING THIS LCD TV/DVD COMBINATION AS A GIFT FROM THE ORIGINAL CONSUMER PURCHASER AND TO NO OTHER PURCHASER OR TRANSFEREE. LCD TV/ DVD COMBINATIONS PURCHASED IN THE U.S.A. OR PUERTO RICO AND USED ANYWHERE OUTSIDE OF THE U.S.A. OR PUERTO RICO, INCLUDING, WITHOUT LIMITATION, CANADA AND MEXICO, ARE NOT COVERED BY THESE WARRANTIES. LCD TV/DVD COMBINATIONS PURCHASED ANYWHERE OUTSIDE OF THE U.S.A. OR PUERTO RICO, INCLUDING, WITHOUT LIMITATION, CANADA AND MEXICO, AND USED IN THE U.S.A., ARE NOT COVERED BY THESE WARRANTIES.

Limited One (1) Year Warranty on Parts and Labor

TAIS WARRANTS THIS LCD TV/DVD COMBINATION AND ITS PARTS AGAINST DEFECTS IN MATERIALS OR WORKMANSHIP FOR A PERIOD OF ONE (1) YEAR FROM THE DATE OF ORIGINAL RETAIL PURCHASE. DURING THIS PERIOD, TAIS WILL, AT TAIS' SOLE DISCRETION, REPAIR OR REPLACE A DEFECTIVE PART/PRODUCT WITH A NEW OR REFURBISHED PART/PRODUCT WITHOUT CHARGE TO YOU FOR PARTS OR LABOR. ANY PART OR PRODUCT REPLACED UNDER THIS LIMITED WARRANTY BECOMES THE PROPERTY OF TAIS. IN SOME CASES, YOU MAY BE RESPONSIBLE FOR DELIVERING THE PRODUCT TO A SERVICE CENTER.

Rental Units

The limited warranty period begins on the date of the first rental or thirty (30) days after the date of shipment to the rental firm, whichever comes first.

Your Responsibility

Read the owner's manual thoroughly before installing or operating this LCD TV/DVD Combination. Complete and mail the enclosed product registration card (if provided) or register your LCD TV/DVD Combination online at support.toshiba.com. Registration of your LCD TV/DVD Combination will enable TAIS to contact you in the unlikely event a safety notification is required under the U.S. Consumer Product Safety Act. Failure to complete and return the product registration card does not diminish your warranty rights.

THE ABOVE WARRANTIES ARE SUBJECT TO THE FOLLOWING CONDITIONS:

- (1) This Limited Warranty is extended only to the original purchaser and only covers product purchased as new.
- (2) A purchase receipt or other proof of the original purchase date is required for warranty service.
- (3) All warranty servicing of this LCD TV/DVD Combination must be performed by an Authorized TAIS Service Provider.
- (4) The warranties from TAIS are effective only if this LCD TV/DVD Combination is purchased and operated in the U.S.A. or Puerto Rico.
- (5) Removal and reinstallation of product that is mounted in such a manner as to impede normal service is not covered under these warranties. This includes wall mounts, custom cabinets and other installation methods that do not provide for direct and immediate access to the product for service purposes. Labor service charges for set installation, setup, adjustment of customer controls, and installation or repair of antenna, satellite or cable systems are not covered by this limited warranty.

- (6) Reception or other problems caused by inadequate antenna systems, misaligned satellite dishes, improperly installed cable drops or use with non-standard signals or sources are your responsibility and are not covered by this limited warranty.
- (7) This limited warranty is void if the product is used outside the range of the temperature (heat/cold) and/or moisture operating conditions as outlined in the product's specification listed in the Owner's manual, or if the product is exposed to excessive smoke, dust, or other airborne contaminants or environmental conditions.
- (8) Warranties extend only to defects in materials or workmanship as limited above, and do not extend to any LCD TV/DVD Combination or parts that have been lost or discarded by you or to damage to the LCD TV/ DVD Combination or parts caused by fires, misuse, abuse, accident, Acts of God (such as lightning or fluctuations in electric power), improper installation, improper maintenance, or use in violation of instructions furnished by TAIS; use or malfunction through simultaneous use of this LCD TV/DVD Combination and connected equipment; or to units that have been modified or had the serial number removed, altered, defaced, or rendered illegible.
- (9) Product purchased "AS-IS" or "With known faults, defects or problems" are not covered by this limited warranty.
- (10) Product previously owned or registered by a consumer and resold is not covered by this limited warranty.
- (11) Product that is refurbished and resold is not covered under this limited warranty.

How to Obtain Warranty Service

After following all of the operating instructions in the Owner's manual, review the section entitled "Concierge" located on our Customer Support Web site at support.toshiba.com. If you find that service is needed, follow the instructions provided on the web site or please contact TAIS' Consumer Solution Center toll free at 1-800-631-3811. You must present upon request your original bill of sale or other proof of purchase including the serial number for in warranty service.

ALL WARRANTIES IMPLIED BY THE LAW OF ANY STATE OF THE U.S.A., INCLUDING THE IMPLIED WARRANTIES OF MERCHANTABILITY AND FITNESS FOR A PARTICULAR PURPOSE, ARE EXPRESSLY LIMITED TO THE DURATION OF THE LIMITED WARRANTIES SET FORTH ABOVE. WITH THE EXCEPTION OF ANY WARRANTIES IMPLIED BY THE LAW OF ANY STATE OF THE U.S.A. AS HEREBY LIMITED, THE FOREGOING LIMITED WARRANTY IS EXCLUSIVE AND IN LIEU OF ALL OTHER WARRANTIES, GUARANTEES, AGREEMENTS, AND SIMILAR OBLIGATIONS OF TAIS WITH RESPECT TO THE REPAIR OR REPLACEMENT OF ANY PARTS. IN NO EVENT SHALL TAIS BE LIABLE FOR CONSEQUENTIAL OR INCIDENTAL DAMAGES (INCLUDING, BUT NOT LIMITED TO, LOST PROFITS, BUSINESS INTERRUPTION, OR MODIFICATION OR ERASURE OF RECORDED DATA CAUSED BY USE, MISUSE OR INABILITY TO USE THIS LCD TV/DVD COMBINATION).

No person, agent, distributor, dealer or company is authorized to change, modify or extend the terms of these warranties in any manner whatsoever. The time within which an action must be commenced to enforce any obligation of TAIS arising under this limited warranty or under any statute, or law of the United States or any state thereof, is hereby limited to ninety (90) days from the date you discover or should have discovered, the defect. This limitation does not apply to implied warranties arising under the law of any state of the U.S.A.

(continued)

THIS LIMITED WARRANTY GIVES YOU SPECIFIC LEGAL RIGHTS AND YOU MAY ALSO HAVE OTHER RIGHTS WHICH MAY VARY FROM STATE TO STATE IN THE U.S.A. SOME STATES OF THE U.S.A. DO NOT ALLOW LIMITATIONS ON THE DURATION OF AN IMPLIED WARRANTY, WHEN AN ACTION MAY BE BROUGHT, OR THE EXCLUSION OR LIMITATION OF INCIDENTAL OR CONSEQUENTIAL DAMAGES. THEREFORE, THE ABOVE PROVISIONS MAY NOT APPLY TO YOU UNDER SUCH CIRCUMSTANCES.

Limited Canadian Warranty for Toshiba Brand Flat Panel Televisions

Toshiba of Canada Limited ("TCL") makes the following limited warranties to original consumers in Canada.

THESE LIMITED WARRANTIES EXTEND TO THE ORIGINAL CONSUMER PURCHASER OR ANY PERSON RECEIVING THIS TOSHIBA BRAND FLAT PANEL TELEVISION (the "TELEVISION(S)" or "Television(s)") AS A GIFT FROM THE ORIGINAL CONSUMER PURCHASER AND TO NO OTHER PURCHASER OR TRANSFEREE.

TELEVISIONS PURCHASED IN CANADA, AND USED ANYWHERE OUTSIDE OF CANADA INCLUDING, WITHOUT LIMITATION, THE UNITED STATES AND MEXICO, ARE NOT COVERED BY THESE WARRANTIES.

TELEVISIONS PURCHASED ANYWHERE OUTSIDE OF CANADA, INCLUDING, WITHOUT LIMITATION, THE UNITED STATES AND MEXICO, AND USED IN CANADA, ARE NOT COVERED BY THESE WARRANTIES.

Limited One (1) Year Warranty on Parts and Labour

TCL warrants the Television and its parts against material defects in materials or workmanship that result in the Television failing for a period of one (1) year after the date of original retail purchase.

DURING THIS PERIOD, TCL WILL, AT TCL'S OPTION, REPAIR OR REPLACE A DEFECTIVE PART WITH A NEW OR RECERTIFIED PART WITHOUT CHARGE TO YOU FOR PARTS OR LABOUR.

Rental Units

The warranty for Television rental units begins with the date of first rental or thirty (30) days from the date of shipment to the rental firm, whichever comes first.

Your Responsibility

Read the owner's manual thoroughly before operating this LCD TV/DVD Combination. Complete and mail the enclosed product registration card or register your LCD TV/DVD Combination online at support.toshiba.ca/warranty/. Registration of your LCD TV/DVD Combination will enable TCL to contact you in the unlikely event of a product safety notice. Failure to complete the product registration does not diminish your warranty rights.

THE ABOVE WARRANTIES ARE SUBJECT TO THE FOLLOWING CONDITIONS:

- (1) You must provide your bill of sale or other proof of purchase.
- (2) All warranty servicing of this Television must be performed by a Toshiba Authorized Service Provider (ASP).
- (3) The warranties from TCL are effective only if the Television is (i) purchased as new and unopened from TCL or from TCL's authorized distributors, dealers or resellers ("ADR's") and (ii) located/operated in Canada.
- (4) Removal and reinstallation of product that is mounted in such a manner as to impede normal service is not covered under these warranties. This

includes wall mounts, custom cabinets and other installation methods that do not provide for direct and immediate access to the product for service purposes. Labour charges for set installation, setup, adjustment of customer controls, and installation or repair of antenna systems are not covered by these warranties. Reception problems caused by inadequate antenna systems are your responsibility.

- (5) Warranties extend only to material defects in materials or workmanship as limited above, and do not extend to:
 - a. Service, repairs or replacement made necessary by accident, misuse, abuse, moisture, liquids, dust, dirt, neglect, accident, damage, 24/7 applications, improper installation, improper operation, improper cleaning, improper maintenance, normal wear and tear, screen burn or image retention caused by prolonged display of static images and/or phosphor aging, or any other external cause or event, act or omission outside the control of TCL, including fire, theft, acts of God, alteration, power failures, power surges or power shortages, lightning, other electrical faults, or repairs, modifications or replacements by persons other than those authorized by TCL to service the Television;
 - b. Replacement of missing, discarded or lost parts, the provision of retrofits, or preventive maintenance;
 - c. Repair of damage that is cosmetic only or does not affect the Television functionality, such as wear and tear, scratches and dents;
 - d. Service on Toshiba-branded accessory items (such as accessory items may be covered by their own warranty);
 - e. Service on third party products or service made necessary by use of incompatible third party products;
 - f. Service made necessary by the simultaneous use of this Television and connected equipment;
 - g. Modifications to the Television not approved in writing by TCL, and service made necessary by the use or installation of non-Toshiba modifications to the Television;
 - h. Service of a Television on which the TOSHIBA label or logo, rating label or serial number have been defaced or removed;
 - i. Damage to the Television caused by failure to follow the specifications, User manuals or guides as to usage and/or storage.
 - j. Firmware updates that are posted to the Toshiba Support website and can be performed by the end user via a USB stick or SD card type media.

Disclaimer and Limitation of Remedy

TO THE EXTENT NOT PRECLUDED BY LAW, ALL OTHER EXPRESS AND IMPLIED WARRANTIES, CONDITIONS AND REPRESENTATIONS FOR THIS TELEVISION, INCLUDING THE IMPLIED WARRANTIES, CONDITIONS AND REPRESENTATIONS OF MERCHANTABILITY AND FITNESS FOR A PARTICULAR PURPOSE, ARE HEREBY DISCLAIMED AND EXCLUDED. IF THE APPLICABLE LAW, STATUTORY OR OTHERWISE, PRECLUDES THE EXCLUSION OF ANY IMPLIED WARRANTIES, CONDITIONS AND REPRESENTATIONS THEN SUCH IMPLIED WARRANTIES, CONDITIONS AND REPRESENTATIONS ARE OTHERWISE LIMITED IN DURATION TO THE TERM OF THIS EXPRESS WRITTEN LIMITED WARRANTY. TO THE EXTENT NOT PRECLUDED BY LAW, STATUTORY OR OTHERWISE, THIS WRITTEN WARRANTY SUPERCEDES AND SPECIFICALLY DISCLAIMS ANY OTHER WARRANTY, CONDITION OR REPRESENTATION NOT STATED IN THIS WARRANTY, WHETHER MADE BY TCL, TOSHIBA

(continued)

CORPORATION, THEIR AFFILIATES, ADRs AND ASPs AND WHETHER MADE ORALLY OR IN WRITING (INCLUDING ANY STATEMENT IN ANY BROCHURE, PRESS RELEASE, ANNOUNCEMENT, ADVERTISEMENT, POINT OF SALE DISPLAY, ETC.).

YOU MUST READ AND FOLLOW ALL SET-UP AND USAGE INSTRUCTIONS IN THE APPLICABLE USER GUIDES AND/OR MANUALS. IF YOU FAIL TO DO SO, THIS TELEVISION MAY NOT FUNCTION PROPERLY AND YOU MAY SUFFER DAMAGE. THIS WARRANTY WILL NOT COVER ANY SERVICE THAT IS REQUIRED, IN PART OR IN WHOLE, AS A RESULT OF ANY FAILURE TO FOLLOW THE SET-UP AND USAGE INSTRUCTIONS. THIS WARRANTY DOES NOT APPLY AND SHALL BE VOID AND UNENFORCEABLE. IF THE TELEVISION IS OPENED, SERVICED, OR REPAIRED BY PERSONS OTHER THAN THOSE AUTHORIZED BY TCL TO SERVICE OR REPAIR THE TELEVISION.

IF THE TELEVISION FAILS TO WORK AS WARRANTED ABOVE, YOUR SOLE AND EXCLUSIVE REMEDY SHALL BE REPAIR OR REPLACEMENT OF THE DEFECTIVE PART. IN NO EVENT WILL TCL, TOSHIBA CORPORATION, THEIR AFFILIATES, ADRs OR ASPs (THE "RELATED PARTIES") BE LIABLE TO YOU OR ANY THIRD PARTY FOR ANY DAMAGES, MONEY, REIMBURSEMENT, COSTS OR EXPENSES. THIS LIMITATION APPLIES TO DAMAGES, MONEY, REIMBURSEMENT, COSTS OR EXPENSES OF ANY KIND WHATSOEVER INCLUDING ANY DIRECT OR INDIRECT DAMAGES, DAMAGE TO PROPERTY OR PERSON, LOST PROFITS, LOST SAVINGS, INCONVENIENCE OR OTHER SPECIAL, INCIDENTAL, EXEMPLARY OR CONSEQUENTIAL DAMAGES, WHETHER FOR BREACH OF WARRANTY, BREACH OF CONTRACT, TORT (INCLUDING NEGLIGENCE), UNDER A STATUTE OR UNDER ANY OTHER LAW OR FORM OR ACTION, OR WHETHER ARISING OUT OF THE USE OF OR INABILITY TO USE THE TELEVISION, EVEN IF ANY OF THE RELATED PARTIES HAS BEEN ADVISED OF THE POSSIBILITY OF SUCH DAMAGES OR OF ANY CLAIM BY ANY OTHER PARTY.

No person, agent, distributor, dealer or company is authorized to change, modify or extend the terms of these warranties in any manner whatsoever.

Arbitration and Dispute Resolution

To the extent not precluded by law, any claim, dispute, controversy or disagreement (whether for breach of warranty, breach of contract, tort (including negligence), under a statute or under any other law or form of action) against any of the Related Parties arising out of, or otherwise relating to: (i) this warranty; (ii) the Television; (iii) any oral or written representations, statements, brochures, press releases, advertising, announcement, point of sale display, or promotional material relating to the Television; (iv) the relationships that result from this warranty, (the foregoing claims, disputes controversies and disagreements are collectively referred to as the "Dispute"), shall be referred to and resolved by final and binding arbitration (to the exclusion of the courts).

To the extent not precluded by law, you agree to waive any right that you may have to commence or participate in any representative or class proceeding against the Related Parties relating to any Dispute. If and where

applicable and to the extent not precluded by law, you further agree to opt out of any such representative or class proceedings. Arbitration of any Dispute will be conducted in the forum and in the manner as agreed to between you and TCL. Failing such agreement, the arbitration will be conducted by one arbitrator pursuant to the laws and rules relating to arbitration generally in force in the jurisdiction in which you reside at the time that the Dispute arises. To the extent not precluded by law, no claim, dispute, controversy or disagreement of any other person may be joined or combined with any Dispute by you, without the prior written consent of TCL.

Critical Applications

The Television you have purchased is not designed for any "critical applications." "Critical applications" means life support systems, medical applications, connections to implanted medical devices, commercial transportation, nuclear facilities or systems or any other applications where Television failure could lead to injury to persons or loss of life or catastrophic property damage.

IF THE CUSTOMER USES THE TELEVISION IN ANY CRITICAL APPLICATION, THE CUSTOMER – AND NOT TCL, ITS AFFILIATES, ADRs OR ASPs – ASSUME SOLE AND FULL RESPONSIBILITY FOR SUCH USE. TCL RESERVES THE RIGHT TO REFUSE TO SERVICE ANY TELEVISION USED IN A CRITICAL APPLICATION. TCL, ITS AFFILIATES, ADRs AND ASPs HEREBY DISCLAIM ANY AND ALL LIABILITY, DAMAGES AND CONSEQUENCES ARISING OUT OF THE SERVICE OR REFUSAL TO SERVICE SUCH TELEVISION AND FURTHER DISCLAIM ANY AND ALL LIABILITY, CONSEQUENCES AND DAMAGES THAT MAY ARISE OR RESULT FROM THE USE OF THE TELEVISION IN ANY CRITICAL APPLICATIONS.

General Provisions

If and to the extent that any provision of this limited warranty should generally be found to be unenforceable, the unenforceable provision shall be severed from the warranty and deemed not to form part of the warranty. The remaining provisions of this warranty shall be and remain valid and enforceable. If and to the extent that any provision of this limited warranty as it relates to any of the Related Parties is found to be invalid or unenforceable in respect of that party (the "Excluded Party"), the Excluded Party shall be deemed to be severed or excluded from the provision, and the provision shall remain valid, enforceable and applicable in respect of the other or remaining Related Parties.

To the extent permitted by law, this limited warranty shall be governed and construed in accordance with the laws of Ontario.

If there is any inconsistency between this limited warranty, on the one hand, and any statement in the packaging of the Television or in any other document enclosed with, or used in the context of the promotion or sale of, the Television, on the other hand, the provisions of this limited warranty shall prevail.

How to Obtain Warranty Services

If, after following all of the operating instructions in this manual, checked the "Troubleshooting" section, and have visited support.toshiba.com. for additional

(continued)

information, you find that service is needed, please contact TCL Customer Support toll free at 1 800 268-3404.

A copy of the GPL source code in this product may be obtained by contacting Toshiba Consumer Solutions at (800) 631-3811. There will be a charge to cover the costs of providing the source code.

A copy of the LGPL source code in this product may be obtained by contacting Toshiba Consumer Solutions at (800) 631-3811. There will be a charge to cover the costs of providing the source code.

Portions of this software are copyright © <2007> The FreeType Project (www.freetype.org). All rights reserved.

This software is based in part on the work of the Independent JPEG Group.

MPEG Layer-3 audio compression technology licensed by Fraunhofer IIS and THOMSON multimedia.

The GNU General Public License (GPL) Version 2, June 1991

Copyright (C) 1989, 1991 Free Software Foundation, Inc.

59 Temple Place, Suite 330, Boston, MA 02111-1307 USA

Everyone is permitted to copy and distribute verbatim copies of this license document, but changing it is not allowed.

Preamble

The licenses for most software are designed to take away your freedom to share and change it. By contrast, the GNU General Public License is intended to guarantee your freedom to share and change free software—to make sure the software is free for all its users. This General Public License applies to most of the Free Software Foundation's software and to any other program whose authors commit to using it. (Some other Free Software Foundation software is covered by the GNU Library General Public License instead.) You can apply it to your programs, too.

When we speak of free software, we are referring to freedom, not price. Our General Public Licenses are designed to make sure that you have the freedom to distribute copies of free software (and charge for this service if you wish), that you receive source code or can get it if you want it, that you can change the software or use pieces of it in new free programs; and that you know you can do these things.

To protect your rights, we need to make restrictions that forbid anyone to deny you these rights or to ask you to surrender the rights. These restrictions translate to certain responsibilities for you if you distribute copies of the software, or if you modify it.

For example, if you distribute copies of such a program, whether gratis or for a fee, you must give the recipients all the rights that you have. You must make sure that they, too, receive or can get the source code. And you must show them these terms so they know their rights. We protect your rights with two steps: (1) copyright the software, and (2) offer you this license which gives you

legal permission to copy, distribute and/or modify the software.

Also, for each author's protection and ours, we want to make certain that everyone understands that there is no warranty for this free software. If the software is modified by someone else and passed on, we want its recipients to know that what they have is not the original, so that any problems introduced by others will not reflect on the original authors' reputations.

Finally, any free program is threatened constantly by software patents. We wish to avoid the danger that redistributors of a free program will individually obtain patent licenses, in effect making the program proprietary. To prevent this, we have made it clear that any patent must be licensed for everyone's free use or not licensed at all.

The precise terms and conditions for copying, distribution and modification follow.

TERMS AND CONDITIONS FOR COPYING, DISTRIBUTION AND MODIFICATION

0. This License applies to any program or other work which contains a notice placed by the copyright holder saying it may be distributed under the terms of this General Public License. The "Program", below, refers to any such program or work, and a "work based on the Program" means either the Program or any derivative work under copyright law: that is to say, a work containing the Program or a portion of it, either verbatim or with modifications and/or translated into another language. (Hereinafter, translation is included without limitation in the term "modification".) Each licensee is addressed as "you".

Activities other than copying, distribution and modification are not covered by this License; they are outside its scope. The act of running the Program is not restricted, and the output from the Program is covered only if its contents constitute a work based on the Program (independent of having been made by running the Program). Whether that is true depends on what the Program does.

1. You may copy and distribute verbatim copies of the Program's source code as you receive it, in any medium, provided that you conspicuously and appropriately publish on each copy an appropriate copyright notice and disclaimer of warranty; keep intact all the notices that refer to this License and to the absence of any warranty; and give any other recipients of the Program a copy of this License along with the Program.

You may charge a fee for the physical act of transferring a copy, and you may at your option offer warranty protection in exchange for a fee.

2. You may modify your copy or copies of the Program or any portion of it, thus forming a work based on the Program, and copy and distribute such modifications or work under the terms of Section 1 above, provided that you also meet all of these conditions:

a) You must cause the modified files to carry prominent notices stating that you changed the files and the date of any change.

b) You must cause any work that you distribute or publish, that in whole or in part contains or is derived from the Program or any part thereof, to be licensed as

(continued)

a whole at no charge to all third parties under the terms of this License.

c) If the modified program normally reads commands interactively when run, you must cause it, when started running for such interactive use in the most ordinary way, to print or display an announcement including an appropriate copyright notice and a notice that there is no warranty (or else, saying that you provide a warranty) and that users may redistribute the program under these conditions, and telling the user how to view a copy of this License. (Exception: if the Program itself is interactive but does not normally print such an announcement, your work based on the Program is not required to print an announcement.)

These requirements apply to the modified work as a whole. If identifiable sections of that work are not derived from the Program, and can be reasonably considered independent and separate works in themselves, then this License, and its terms, do not apply to those sections when you distribute them as separate works. But when you distribute the same sections as part of a whole which is a work based on the Program, the distribution of the whole must be on the terms of this License, whose permissions for other licensees extend to the entire whole, and thus to each and every part regardless of who wrote it.

Thus, it is not the intent of this section to claim rights or contest your rights to work written entirely by you; rather, the intent is to exercise the right to control the distribution of derivative or collective works based on the Program.

In addition, mere aggregation of another work not based on the Program with the Program (or with a work based on the Program) on a volume of a storage or distribution medium does not bring the other work under the scope of this License.

3. You may copy and distribute the Program (or a work based on it, under Section 2) in object code or executable form under the terms of Sections 1 and 2 above provided that you also do one of the following:

- a) Accompany it with the complete corresponding machine-readable source code, which must be distributed under the terms of Sections 1 and 2 above on a medium customarily used for software interchange; or,
- b) Accompany it with a written offer, valid for at least three years, to give any third party, for a charge no more than your cost of physically performing source distribution, a complete machine-readable copy of the corresponding source code, to be distributed under the terms of Sections 1 and 2 above on a medium customarily used for software interchange; or,
- c) Accompany it with the information you received as to the offer to distribute corresponding source code. (This alternative is allowed only for noncommercial distribution and only if you received the program in object code or executable form with such an offer, in accord with Subsection b above.)

The source code for a work means the preferred form of the work for making modifications to it. For an executable work, complete source code means all the source code for all modules it contains, plus any associated interface definition files, plus the scripts used to control compilation and installation of the executable.

However, as a special exception, the source code distributed need not include anything that is normally distributed (in either source or binary form) with the major components (compiler, kernel, and so on) of the operating system on which the executable runs, unless that component itself accompanies the executable.

If distribution of executable or object code is made by offering access to copy from a designated place, then offering

equivalent access to copy the source code from the same place counts as distribution of the source code, even though third parties are not compelled to copy the source along with the object code.

4. You may not copy, modify, sublicense, or distribute the Program except as expressly provided under this License. Any attempt otherwise to copy, modify, sublicense or distribute the Program is void, and will automatically terminate your rights under this License.

However, parties who have received copies, or rights, from you under this License will not have their licenses terminated so long as such parties remain in full compliance.

5. You are not required to accept this License, since you have not signed it. However, nothing else grants you permission to modify or distribute the Program or its derivative works. These actions are prohibited by law if you do not accept this License. Therefore, by modifying or distributing the Program (or any work based on the Program), you indicate your acceptance of this License to do so, and all its terms and conditions for copying, distributing or modifying the Program or works based on it.

6. Each time you redistribute the Program (or any work based on the Program), the recipient automatically receives a license from the original licensor to copy, distribute or modify the Program subject to these terms and conditions. You may not impose any further restrictions on the recipients' exercise of the rights granted herein. You are not responsible for enforcing compliance by third parties to this License.

7. If, as a consequence of a court judgment or allegation of patent infringement or for any other reason (not limited to patent issues), conditions are imposed on you (whether by court order, agreement or otherwise) that contradict the conditions of this License, they do not excuse you from the conditions of this License. If you cannot distribute so as to satisfy simultaneously your obligations under this License and any other pertinent obligations, then as a consequence you may not distribute the Program at all. For example, if a patent license would not permit royalty-free redistribution of the Program by all those who receive copies directly or indirectly through you, then the only way you could satisfy both it and this License would be to refrain entirely from distribution of the Program.

If any portion of this section is held invalid or unenforceable under any particular circumstance, the balance of the section is intended to apply and the section as a whole is intended to apply in other circumstances.

It is not the purpose of this section to induce you to infringe any patents or other property right claims or to contest validity of any such claims; this section has the sole purpose of protecting the integrity of the free software distribution system, which is implemented by public license practices. Many people have made generous contributions to the wide range of software distributed through that system in reliance on consistent application of that system; it is up to the author/donor to decide if he or she is willing to distribute software through any other system and a licensee cannot impose that choice.

This section is intended to make thoroughly clear what is believed to be a consequence of the rest of this License.

8. If the distribution and/or use of the Program is restricted in certain countries either by patents or by copyrighted interfaces, the original copyright holder who places the Program under this License may add an explicit geographical distribution limitation excluding those countries, so that distribution is permitted only in or among countries not thus excluded. In such case, this License incorporates the limitation as if written in the body of this License.

9. The Free Software Foundation may publish revised and/or new versions of the General Public License from time to

(continued)

Chapter 12: Appendix

time. Such new versions will be similar in spirit to the present version, but may differ in detail to address new problems or concerns.

Each version is given a distinguishing version number. If the Program specifies a version number of this License which applies to it and "any later version", you have the option of following the terms and conditions either of that version or of any later version published by the Free Software Foundation. If the Program does not specify a version number of this License, you may choose any version ever published by the Free Software Foundation.

10. If you wish to incorporate parts of the Program into other free programs whose distribution conditions are different, write to the author to ask for permission. For software which is copyrighted by the Free Software Foundation, write to the Free Software Foundation; we sometimes make exceptions for this. Our decision will be guided by the two goals of preserving the free status of all derivatives of our free software and of promoting the sharing and reuse of software generally.

NO WARRANTY

11. BECAUSE THE PROGRAM IS LICENSED FREE OF CHARGE, THERE IS NO WARRANTY FOR THE PROGRAM, TO THE EXTENT PERMITTED BY APPLICABLE LAW. EXCEPT WHEN OTHERWISE STATED IN WRITING THE COPYRIGHT HOLDERS AND/OR OTHER PARTIES PROVIDE THE PROGRAM "AS IS" WITHOUT WARRANTY OF ANY KIND, EITHER EXPRESSED OR IMPLIED, INCLUDING, BUT NOT LIMITED TO, THE IMPLIED WARRANTIES OF MERCHANTABILITY AND FITNESS FOR A PARTICULAR PURPOSE. THE ENTIRE RISK AS TO THE QUALITY AND PERFORMANCE OF THE PROGRAM IS WITH YOU. SHOULD THE PROGRAM PROVE DEFECTIVE, YOU ASSUME THE COST OF ALL NECESSARY SERVICING, REPAIR OR CORRECTION.

12. IN NO EVENT UNLESS REQUIRED BY APPLICABLE LAW OR AGREED TO IN WRITING WILL ANY COPYRIGHT HOLDER, OR ANY OTHER PARTY WHO MAY MODIFY AND/OR REDISTRIBUTE THE PROGRAM AS PERMITTED ABOVE, BE LIABLE TO YOU FOR DAMAGES, INCLUDING ANY GENERAL, SPECIAL, INCIDENTAL OR CONSEQUENTIAL DAMAGES ARISING OUT OF THE USE OR INABILITY TO USE THE PROGRAM (INCLUDING BUT NOT LIMITED TO LOSS OF DATA OR DATA BEING RENDERED INACCURATE OR LOSSES SUSTAINED BY YOU OR THIRD PARTIES OR A FAILURE OF THE PROGRAM TO OPERATE WITH ANY OTHER PROGRAMS), EVEN IF SUCH HOLDER OR OTHER PARTY HAS BEEN ADVISED OF THE POSSIBILITY OF SUCH DAMAGES.

END OF TERMS AND CONDITIONS

How to Apply These Terms to Your New Programs

If you develop a new program, and you want it to be of the greatest possible use to the public, the best way to achieve this is to make it free software which everyone can redistribute and change under these terms.

To do so, attach the following notices to the program. It is safest to attach them to the start of each source file to most effectively convey the exclusion of warranty; and each file should have at least the "copyright" line and a pointer to where the full notice is found.

One line to give the program's name and a brief idea of what it does.

Copyright (C) <year> <name of author>

This program is free software; you can redistribute it

and/or modify it under the terms of the GNU General Public License as published by the Free Software Foundation; either version 2 of the License, or (at your option) any later version.

This program is distributed in the hope that it will be useful, but WITHOUT ANY WARRANTY; without even the implied warranty of MERCHANTABILITY or FITNESS FOR A PARTICULAR PURPOSE. See the GNU General Public License for more details.

You should have received a copy of the GNU General Public License along with this program; if not, write to the Free Software Foundation, Inc., 59 Temple Place, Suite 330, Boston, MA 02111-1307 USA

Also add information on how to contact you by electronic and paper mail.

If the program is interactive, make it output a short notice like this when it starts in an interactive mode:

Gnomovision version 69, Copyright (C) year name of author Gnomovision comes with ABSOLUTELY NO WARRANTY; for details type 'show w'. This is free software, and you are welcome to redistribute it under certain conditions; type 'show c' for details.

The hypothetical commands 'show w' and 'show c' should show the appropriate parts of the General Public License. Of course, the commands you use may be called something other than 'show w' and 'show c'; they could even be mouse-clicks or menu items--whatever suits your program.

You should also get your employer (if you work as a programmer) or your school, if any, to sign a "copyright disclaimer" for the program, if necessary. Here is a sample; alter the names:

Yoyodyne, Inc., hereby disclaims all copyright interest in the program 'Gnomovision' (which makes passes at compilers) written by James Hacker.

signature of Ty Coon, 1 April 1989

Ty Coon, President of Vice

This General Public License does not permit incorporating your program into proprietary programs. If your program is a subroutine library, you may consider it more useful to permit linking proprietary applications with the library. If this is what you want to do, use the GNU Library General Public License instead of this License.

The Libpng License Notices

This copy of the libpng notices is provided for your convenience. In case of any discrepancy between this copy and the notices in the file png.h that is included in the libpng distribution, the latter shall prevail.

COPYRIGHT NOTICE, DISCLAIMER, and LICENSE:

If you modify libpng you may insert additional notices immediately following this sentence.

This code is released under the libpng license.

libpng versions 1.2.6, August 15, 2004, through 1.2.41, December 3, 2009, are Copyright (c) 2004, 2006-2009 Glenn Randers-Pehrson, and are distributed according to the same disclaimer and license as libpng-1.2.5 with the following individual added to the list of Contributing Authors:

Cosmin Truta

libpng versions 1.0.7, July 1, 2000, through 1.2.5 - October 3, 2002, are Copyright (c) 2000-2002 Glenn Randers-Pehrson, and are distributed according to the same disclaimer and license as libpng-1.0.6 with the following individuals added to the list of Contributing

(continued)

Authors:

Simon-Pierre Cadieux
Eric S. Raymond
Gilles Vollant

and with the following additions to the disclaimer:

There is no warranty against interference with your enjoyment of the library or against infringement. There is no warranty that our efforts or the library will fulfill any of your particular purposes or needs. This library is provided with all faults, and the entire risk of satisfactory quality, performance, accuracy, and effort is with the user.

libpng versions 0.97, January 1998, through 1.0.6, March 20, 2000, are Copyright (c) 1998, 1999 Glenn Randers-Pehrson, and are distributed according to the same disclaimer and license as libpng-0.96, with the following individuals added to the list of Contributing Authors:

Tom Lane
Glenn Randers-Pehrson
Willem van Schaik

libpng versions 0.89, June 1996, through 0.96, May 1997, are Copyright (c) 1996, 1997 Andreas Dilger, and are distributed according to the same disclaimer and license as libpng-0.88, with the following individuals added to the list of Contributing Authors:

John Bowler
Kevin Bracey
Sam Bushell
Magnus Holmgren
Greg Roelofs
Tom Tanner

libpng versions 0.5, May 1995, through 0.88, January 1996, are Copyright (c) 1995, 1996 Guy Eric Schalnat, Group 42, Inc.

For the purposes of this copyright and license, "Contributing Authors" is defined as the following set of individuals:

Andreas Dilger
Dave Martindale
Guy Eric Schalnat
Paul Schmidt
Tim Wegner

The PNG Reference Library is supplied "AS IS". The Contributing Authors and Group 42, Inc. disclaim all warranties, expressed or implied, including, without limitation, the warranties of merchantability and of fitness for any purpose. The Contributing Authors and Group 42, Inc. assume no liability for direct, indirect, incidental, special, exemplary, or consequential damages, which may result from the use of the PNG Reference Library, even if advised of the possibility of such damage.

Permission is hereby granted to use, copy, modify, and distribute this source code, or portions hereof, for any purpose, without fee, subject to the following restrictions:

1. The origin of this source code must not be misrepresented.
2. Altered versions must be plainly marked as such and must not be misrepresented as being the original source.
3. This Copyright notice may not be removed or altered from any source or altered source distribution.

The Contributing Authors and Group 42, Inc. specifically permit, without fee, and encourage the use of this source code as a component to supporting the PNG file format in commercial products. If you use this source code in a product, acknowledgment is not required but would be appreciated.

A "png_get_copyright" function is available, for convenient use in "about" boxes and the like:

```
printf("%s",png_get_copyright(NULL));
```

Also, the PNG logo (in PNG format, of course) is supplied in the files "pngbar.png" and "pngbar.jpg" (88x31) and "pngnow.png" (98x31).

Libpng is OSI Certified Open Source Software. OSI Certified Open Source is a certification mark of the Open Source Initiative.

Glenn Randers-Pehrson
glennrp at users.sourceforge.net
December 3, 2009

The zlib License

zlib.h -- interface of the "zlib" general purpose compression library

Version 1.2.3, July 18th, 2005

Copyright (C) 1995-2005 Jean-loup Gailly and Mark Adler

This software is provided "as-is", without any express or implied warranty. In no event will the authors be held liable for any damages arising from the use of this software.

Permission is granted to anyone to use this software for any purpose, including commercial applications, and to alter it and redistribute it freely, subject to the following restrictions:

1. The origin of this software must not be misrepresented; you must not claim that you wrote the original software. If you use this software in a product, an acknowledgment in the product documentation would be appreciated but is not required.
2. Altered source versions must be plainly marked as such, and must not be misrepresented as being the original software.
3. This notice may not be removed or altered from any source distribution.

Jean-loup Gailly jloup@gzip.org
Mark Adler madler@alumni.caltech.edu

Note

TOSHIBA AMERICA INFORMATION SYSTEMS, INC.

Corporate Headquarters: 9740 IRVINE BLVD.; IRVINE, CA 92618 U.S.A.
Visual Products Service and Support Dept: 1420-B TOSHIBA DRIVE, LEBANON, TN
37087, U.S.A. .

TOSHIBA OF CANADA LTD.

HEAD OFFICE: 191 McNABB STREET, MARKHAM, ONTARIO, L3R 8H2, CANADA

CableClear, ColorStream, GameTimer, and TheaterWide are registered trademarks of Toshiba America Information Systems, Inc.

Channel Browser, DynaLight, and SurfLock are trademarks of Toshiba America Information Systems, Inc.

REGZA-LINK is a registered trademark of Toshiba Corporation.

TOSHIBA